

# USER MANUAL



## ***Solar Hybrid Inverter***

**SFE-8K-UP**

**SFE-10K-UP**

**SFE-12K-UP**

# Content

|  |           |
|--|-----------|
| <b>1. Safety</b> .....   | <b>4</b>  |
| 1.1、 How to use this manual .....                                    | 4         |
| 1.2、 Symbols in this manual .....                                    | 4         |
| 1.3、 Safety instruction .....  | 4         |
| <b>2. Production Instructions</b> .....                              | <b>5</b>  |
| 2.1、 Instructions .....  | 5         |
| 2.3、 System connection diagram .....                                 | 6         |
| 2.4、 Production Overview .....                                       | 7         |
| 2.5、 Dimension drawing .....   | 8         |
| <b>3. Installation</b> .....   | <b>9</b>  |
| 3.1、 Select the mount location .....                                 | 9         |
| 3.2、 Mount the inverter .....  | 9         |
| 3.3、 Remove the terminal cover & anti insect net .....               | 10        |
| <b>4. Connection</b> .....   | <b>11</b> |
| 4.1 Split-phase mode .....   | 11        |
| 4.2、 Cable & circuit breaker requirement .....                       | 11        |
| 4.3 GRID & LOAD & GEN connection .....                               | 14        |
| 4.4 Battery Connection .....   | 15        |
| 4.5 PV connection .....  | 15        |
| 4.6 Dry contact connection .....                                     | 16        |
| 4.7 Grounding connection .....                                       | 16        |
| 4.8 Final assembly .....   | 17        |
| 4.9 Start up the inverter .....                                      | 17        |
| 4.9.1 Introduction .....   | 17        |
| 4.9.2 Precautions for connecting the parallel connecting lines ..... | 17        |
| <b>5. Operation</b> .....  | <b>25</b> |
| 5.1、 Operation and display panel .....                               | 25        |
| 5.2、 Setting .....   | 28        |
| 5.3、 Time-slot charging/discharging function .....                   | 40        |
| 5.4、 Battery parameter .....   | 41        |
| <b>6. Communication</b> .....  | <b>43</b> |
| 6.1、 Overview .....  | 43        |
| 6.2、 USB-B port .....  | 43        |
| 6.4、 RS485 port .....  | 44        |
| 6.5、 CAN port .....  | 45        |
| 6.5、 External CT port .....  | 46        |
| 6.6、 Dry contact .....   | 46        |
| <b>7. Fault and Remedy</b> .....                                     | <b>48</b> |





|  |           |
|--|-----------|
| <b>8. Protection and Maintenance .....</b> | <b>53</b> |
| 8.1 Protection features .....              | 53        |
| 8.2 Maintenance .....                      | 55        |
| <b>9. Datasheet .....</b>                  | <b>56</b> |

# 1. Safety

## 1.1. How to use this manual









- This manual contains important information, guidelines, operation and maintenance for the following products  
**SEI Series : 8K-UP , 10K-UP , 12K-UP**
- The manual must be followed during installation and maintenance

## 1.2. Symbols in this manual

| Symbol   | Description   |
|--|---|
|  <b>DANGER</b>  | DANGER indicates a hazardous situations which if not avoided will result in death or serious injury.    |
|  <b>WARNING</b> | WARNING indicates a hazardous situations which if not avoided could result in death or serious injury.  |
|  <b>CAUTION</b> | CAUTION indicates a hazardous situations which if not avoided could result in minor or moderate injury. |
|  <b>NOTICE</b> | NOTICE provide some tips on operation of products.  |

## 1.3. Safety instruction

 **DANGER**

-  This chapter contains important safety instructions. Read and keep this manual for future reference.
-  Be sure to comply the local requirements and regulation to install this inverter.
-  Beware of high voltage. Please turn off the switch of each power sources before and during the installation to avoid electric shock.
-  For optimum operation of this inverter, please follow required specification to select appropriate cable size and necessary protective device.
-  Do not connect or disconnect any connections when the inverter is working.
-  Do not open the terminal cover when the inverter working.
-  Make sure the inverter is well grounding.
-  Never cause AC output and DC input short circuited.
-  Do not disassembly this unit, for all repair and maintenance, please take it to the professional service center.

## 2. Production Instructions

### 2.1、 Instructions

SEI series is a new type of solar energy storage inverter control inverter integrating solar energy storage & utility charging and energy storage, AC sine wave output. It adopts DSP control and features high response speed, reliability, and industrial standard through an advanced control algorithm.

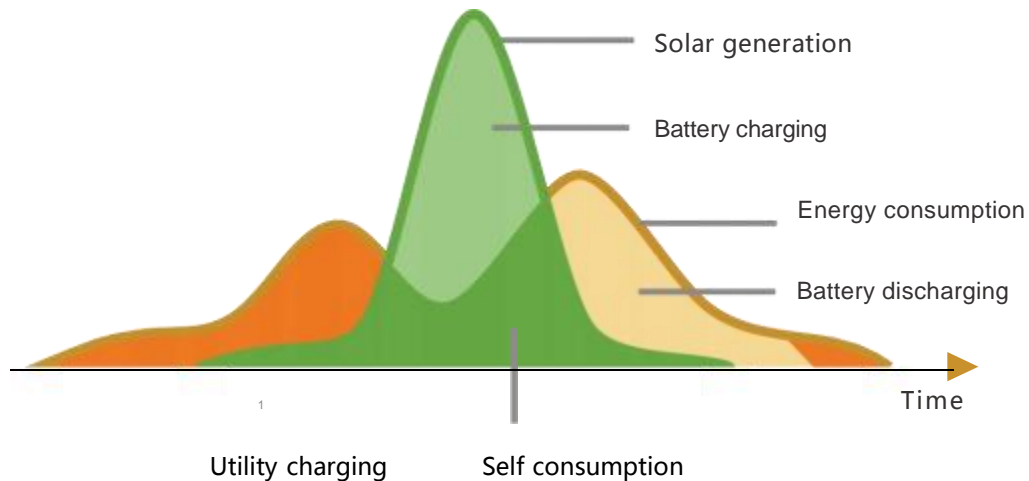

### 2.2、 Features

- ☞ Supports lead acid battery and li-ion battery connections.
- ☞ With a dual activation function when the li-ion battery is dormant; either mains/photovoltaic power supply access can trigger the activation of the li-ion battery.
- ☞ Support single-phase pure sine wave output.
- ☞ Supports four different voltage levels of 100\105\110\120\127Vac per phase.
- ☞ Supports two solar inputs and simultaneous tracking of two solar maximum power charging/carrying capacity functions.
- ☞ Dual MPPT with 99.9% efficiency and maximum 25A current in a single circuit, perfectly adapted to high power modules.
- ☞ 2 charging modes are available: solar only, grid/solar hybrid charging.
- ☞ With the time-slot charging and discharging setting function, you can set the time period for cutting in/out of mains charging and switch the time period between battery discharging and mains bypass power supply mode.
- ☞ Energy saving mode function to reduce no-load energy losses.
- ☞ With two output modes of utility bypass and inverter output, with uninterrupted power supply function.
- ☞ LCD large screen dynamic flow diagram design, easy to understand the system data and operation status.
- ☞ 360° protection with complete short circuit protection, over current protection, over under voltage protection, overload protection, backfill protection, etc.
- ☞ Support CAN, USB, and RS485 communication.

## 2.3、 System connection diagram

The diagram below shows the system application scenario of this product. A complete system consists of the following components:

- ☞ **PV modules:** converts light energy into DC energy, which can be used to charge the battery via an inverter or directly inverted into AC power to supply the load.
- ☞ **Utility grid or generator:** connected to the AC input, it can supply the load and charge the battery at the same time. The system can also operate generally without the mains or generator when the battery and the PV module power the load.
- ☞ **Battery:** The role of the battery is to ensure the regular power supply of the system load when the solar energy is insufficient and there is no mains power.
- ☞ **Home load:** Various household and office loads can be connected, including refrigerators, lamps, televisions, fans, air conditioners, and other AC loads.
- ☞ **Inverter:** The energy conversion device of the whole system.

The actual application scenario determines the specific system wiring method

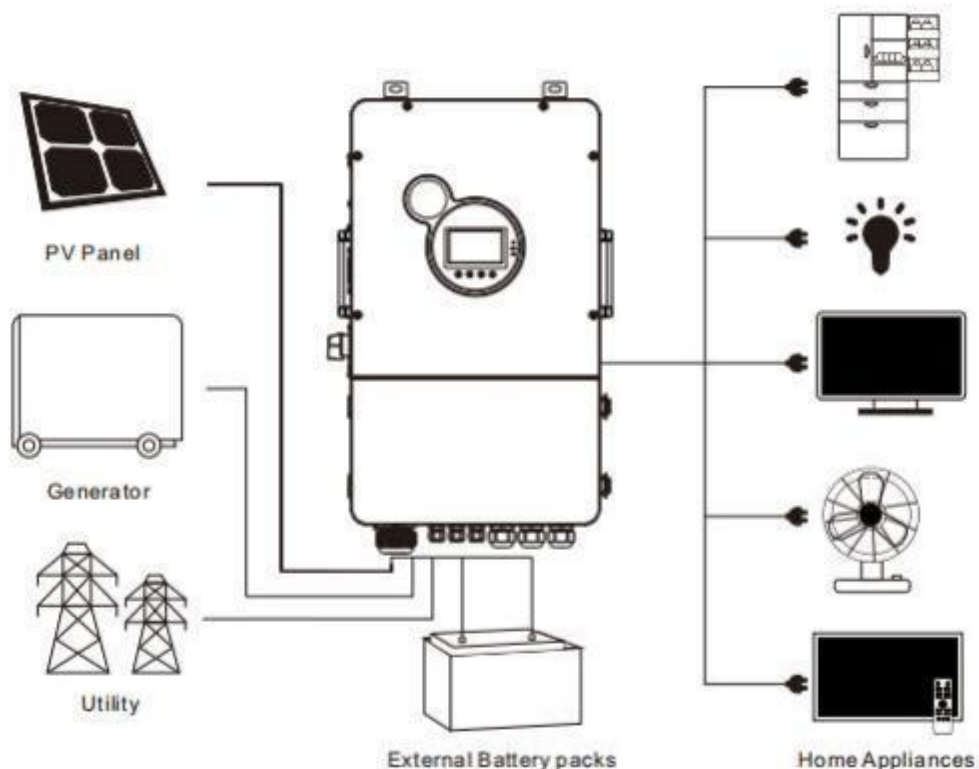

## 2.4、 Production Overview

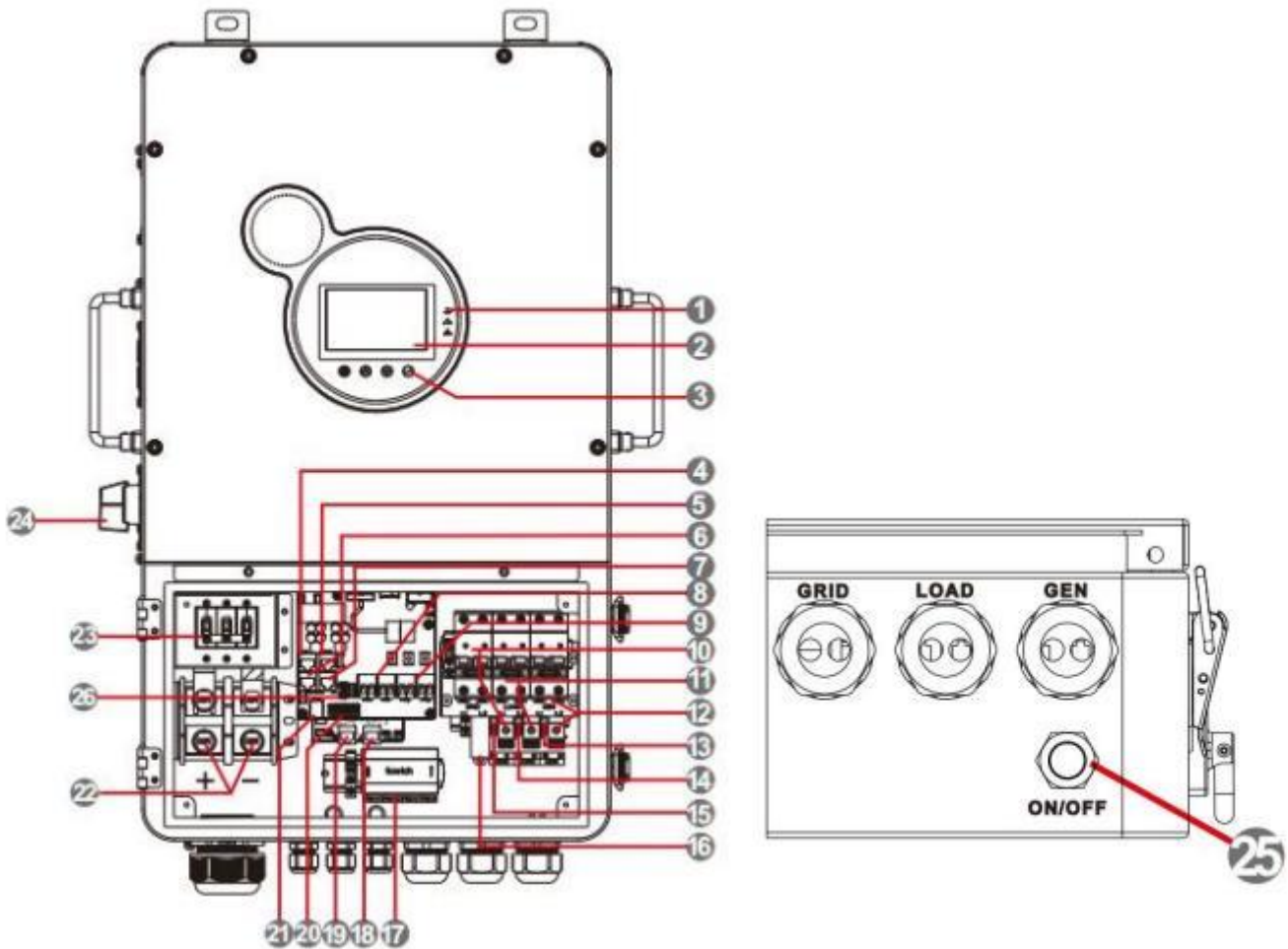

|    |   |    |                            |
|----|---|----|----------------------------|
| 1  | LED Indicators                                | 14 | Load ground terminal       |
| 2  | LCD screen                                    | 15 | Grid input ground terminal |
| 3  | mechanical key                                | 16 | RSD                        |
| 4  | WIFI port                                     | 17 | AFCI                       |
| 5  | RS485 port                                    | 18 | Parallel port A            |
| 6  | External CT port                              | 19 | Parallel port B            |
| 7  | CAN port                                      | 20 | Dry contact                |
| 8  | PV1 terminals                                 | 21 | USB-B port                 |
| 9  | PV2 terminals                                 | 22 | Battery Terminal           |
| 10 | Utility terminals (L1+L2+N) +breaker          | 23 | Battery Circuit Breaker    |
| 11 | Load terminals ( L1+L2+N ) +Breaker           | 24 | PV Circuit Breaker         |
| 12 | Generator input terminal ( L1+L2+N ) +Breaker | 25 | ON/OFF switch              |
| 13 | Generator Ground Terminal                     | 26 | USB-A port                 |

## 2.5、 Dimension drawing

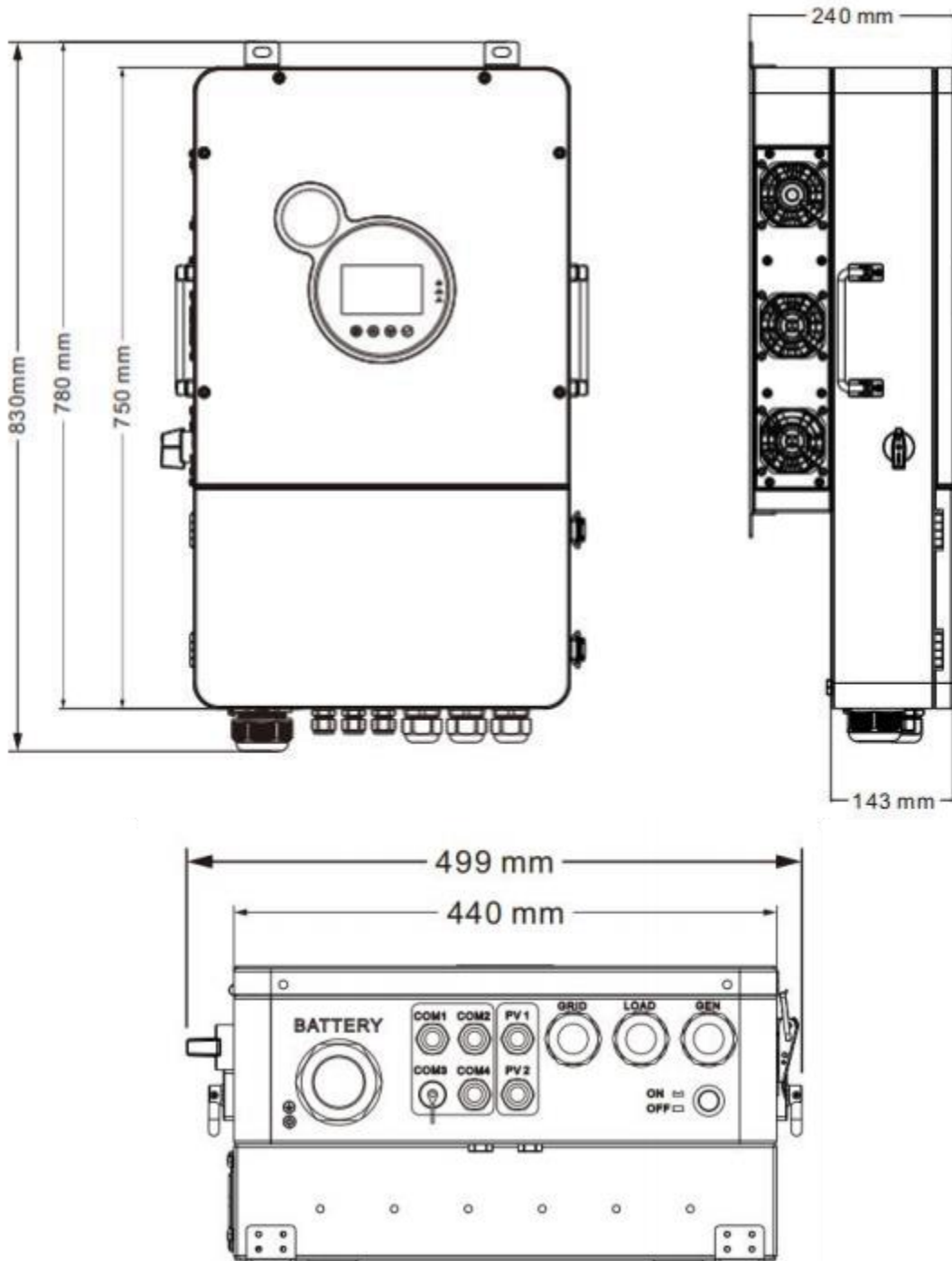



## 3. Installation

### 3.1. Select the mount location

SEI series can be used outdoors (protection class IP65). Please consider the followings before selecting the location :

- ☞ Choose the solid wall to install the inverter
- ☞ Mount the inverter at eye level
- ☞ Adequate heat dissipation space must be provided for the inverter
- ☞ Installation location is a cool and ventilated place, under the photovoltaic panels or under the eaves, do not direct sunlight exposure
- ☞ The ambient temperature should be between -25~60°C ( -13~140°F) to ensure optimal operation

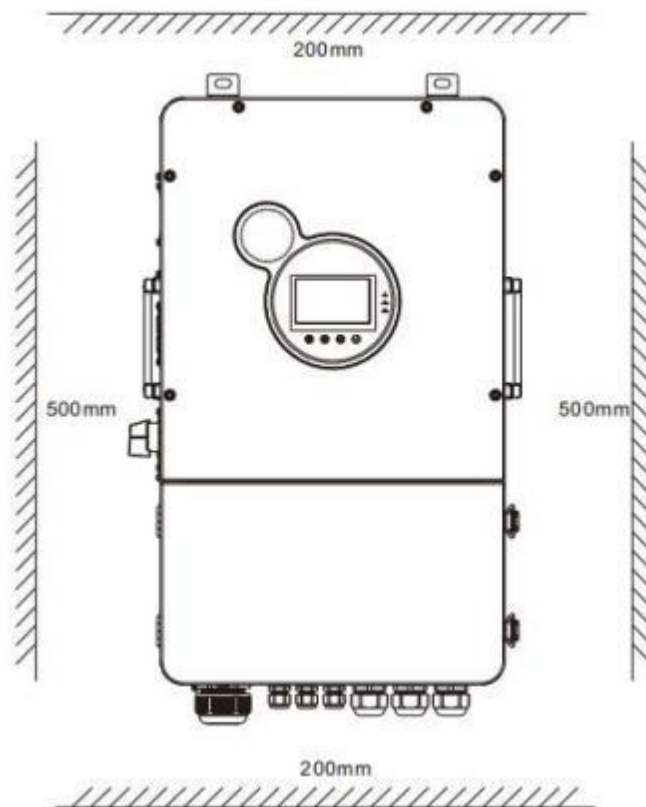

#### ⚠ **DANGER**

- ☞ Do not install the inverter near flammable materials
- ☞ Do not install the inverter in potentially explosive areas
- ☞ Do not install the inverter and lead-acid batteries in enclosed spaces."

#### ⚠ **CAUTION**

- ☞ Do not install the inverter in direct sunlight.

### 3.2. Mount the inverter

Punch 4 mounting holes in the wall with an electric drill according to the specified size, and insert four M8\*60 expansion screws above.

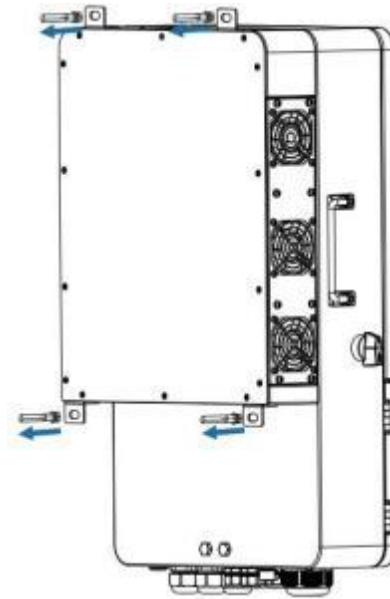
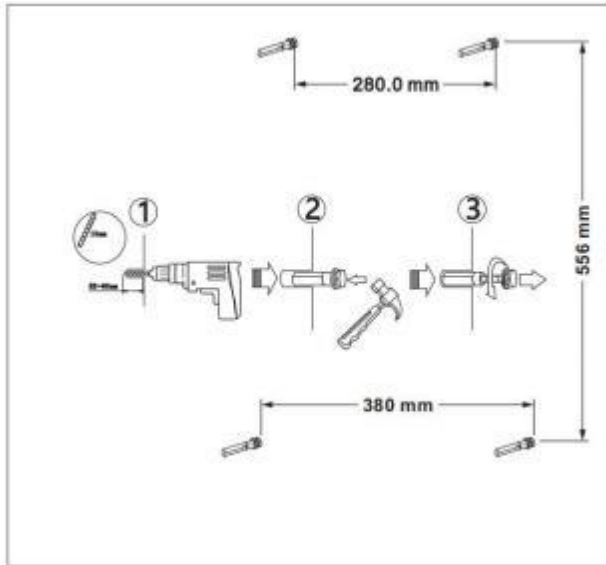

### 3.3、 Remove the terminal cover & anti insect net

Using a screwdriver, remove the fan shroud and open the cover.

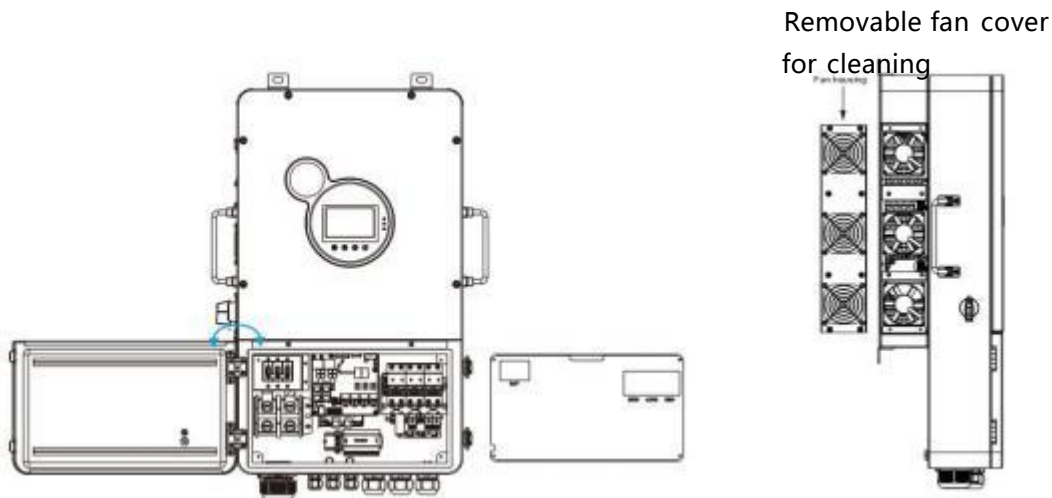

o! **NOTICE**

 When using the device in areas with poor air quality, the fan cover is easily blocked by air particles, please disassemble and clean the fan regularly to avoid affecting the inverter's internal air flow rate, which may trigger the device over-temperature protection fault (19/20 faults) affecting the power supply and the service life of the inverter.

## 4. Connection

### 4.1 Split-phase mode

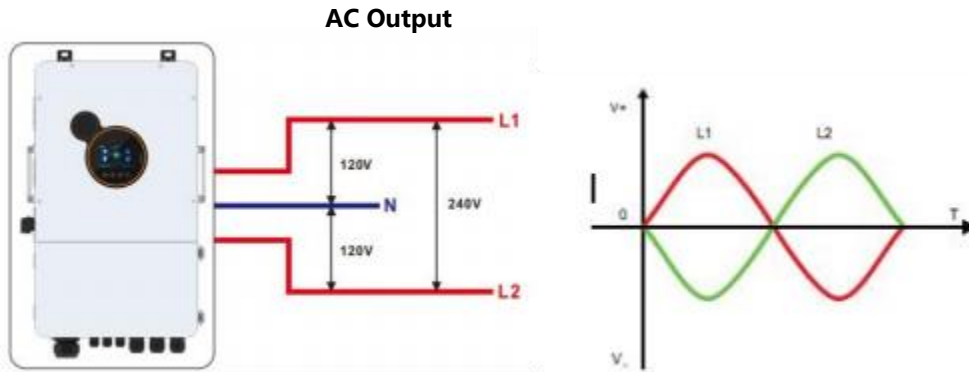

| Items                          | Description                    |
|--------------------------------|--------------------------------|
| Applicable Model               | SEI series U model             |
| AC Output Phase Voltage (L-N)  | 100 ~120Vac, 120Vac (default)  |
| AC Output Line Voltage (L1-L2) | 200 ~240Vac , 240Vac (default) |

### 4.2. Cable & circuit breaker requirement



#### PV INPUT

| Model      | No. of PV | Cable Diameter            | Max. PV Input Current | Circuit Breaker Spec |
|------------|-----------|---------------------------|-----------------------|----------------------|
| SEI-8K-UP  | PV1       | 5mm <sup>2</sup> / 10 AWG | 25A                   | 2P-25A               |
|            | PV2       | 5mm <sup>2</sup> / 10 AWG | 25A                   | 2P-25A               |
| SEI-10K-UP | PV1       | 5mm <sup>2</sup> / 10 AWG | 25A                   | 2P-25A               |
|            | PV2       | 5mm <sup>2</sup> / 10 AWG | 25A                   | 2P-25A               |
| SEI-12K-UP | PV1       | 5mm <sup>2</sup> / 10 AWG | 25A                   | 2P-25A               |
|            | PV2       | 5mm <sup>2</sup> / 10 AWG | 25A                   | 2P-25A               |



#### BATTERY

| Model      | Cable Diameter            | Max. Battery Current | Circuit Breaker Spec |
|------------|---------------------------|----------------------|----------------------|
| SEI-8K-UP  | 34mm <sup>2</sup> / 2 AWG | 200A                 | 2P-250A              |
| SEI-10K-UP | 42mm <sup>2</sup> / 1 AWG | 230A                 | 2P-250A              |
| SEI-12K-UP | 54mm <sup>2</sup> / 0 AWG | 270A                 | 2P-300A              |



 **AC INPUT**

| Model      | Schema  | Cable Diameter                       | Circuit Breaker Spec |
|------------|---|--------------------------------------|----------------------|
| SEI-8K-UP  |  | 13mm <sup>2</sup> /6AWG<br>(L1/L2/N) | 3P-63A               |
| SEI-10K-UP |  | 13mm <sup>2</sup> /6AWG<br>(L1/L2/N) | 3P-63A               |
| SEI-12K-UP |  | 13mm <sup>2</sup> /6AWG<br>(L1/L2/N) | 3P-63A               |

 **GENERATOR INPUT**

| Model      | Schema  | Cable Diameter                       | Circuit Breaker Spec |
|------------|---|--------------------------------------|----------------------|
| SEI-8K-UP  |    | 13mm <sup>2</sup> /6AWG<br>(L1/L2/N) | 3P-63A               |
| SEI-10K-UP |   | 13mm <sup>2</sup> /6AWG<br>(L1/L2/N) | 3P-63A               |
| SEI-12K-UP |  | 13mm <sup>2</sup> /6AWG<br>(L1/L2/N) | 3P-63A               |

 **AC OUTPUT**

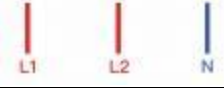
| Model      | Schema  | Cable Diameter                       | Circuit Breaker Spec |
|------------|---|--------------------------------------|----------------------|
| SEI-8K-UP  |  | 13mm <sup>2</sup> /6AWG<br>(L1/L2/N) | 3P-63A               |
| SEI-10K-UP |  | 13mm <sup>2</sup> /6AWG<br>(L1/L2/N) | 3P-63A               |
| SEI-12K-UP |  | 13mm <sup>2</sup> /6AWG<br>(L1/L2/N) | 3P-63A               |

o! **NOTICE**

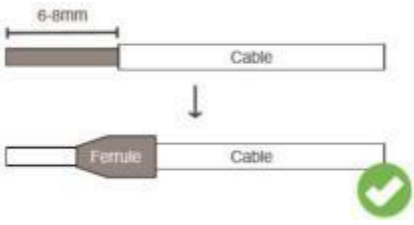
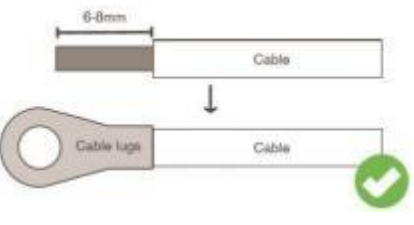
|   |  |
|---|--|
| <ul style="list-style-type: none"> <li>• <b>PV Input, AC Input, AC Output, Generator Input</b></li> </ul> <p>1. Use a stripper to remove the 6 ~ 8mm insulation of the cable</p> <p>2. Fixing a ferrule at the end of the cable. (ferrule needs to be prepared by the user)</p> |  |
| <ul style="list-style-type: none"> <li>• <b>BATTERY</b></li> </ul> <p>1. Use a stripper to remove the 6~8mm insulation of the cable</p> <p>2. Fixing cable lugs that supply with the box at the end of the cable.</p>   |  |

The wire diameter is for reference only. If the distance between the PV array and the inverter or between the inverter and the battery is long, using a thicker wire will reduce the voltage drop and improve the performance of the system.

## 4.3 GRID & LOAD & GEN connection

Connect the live, neutral and ground wires according to the cables' position and order shown in the diagram below.

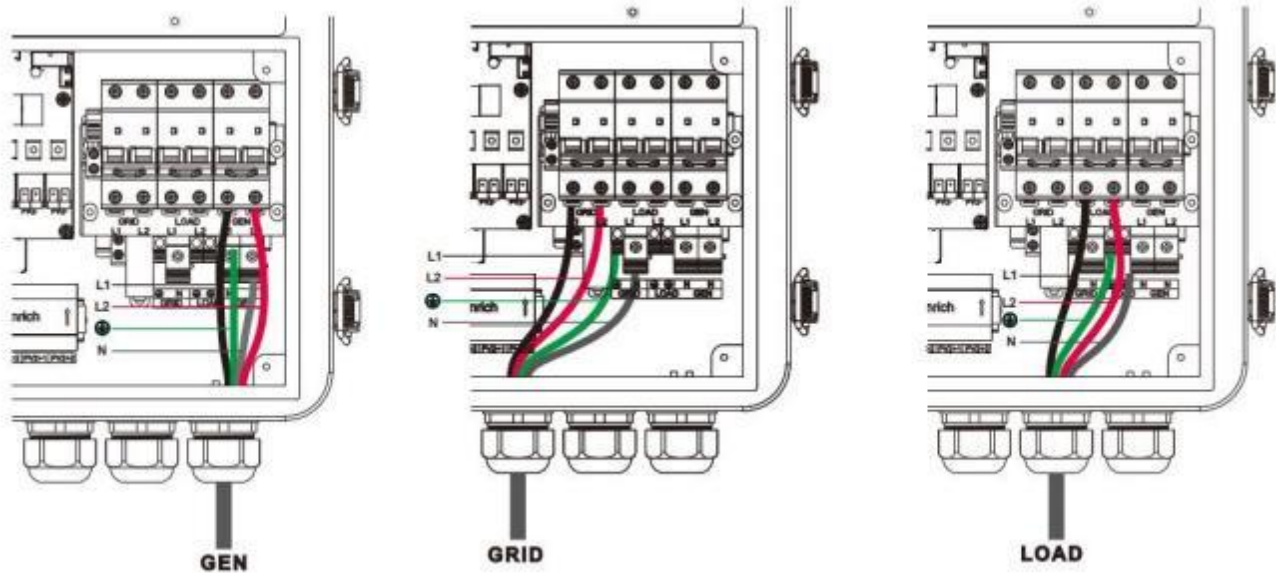

### **⚠ DANGER**

- Before connecting AC inputs and outputs, the circuit breaker must be opened to avoid the risk of electric shock and must not be operated with electricity.
- Please check that the cable used is sufficient for the requirements, too thin, poor quality cables are a serious safety hazard.

## 4.4 Battery Connection

Connect the positive and negative cable of the battery according to the diagram below

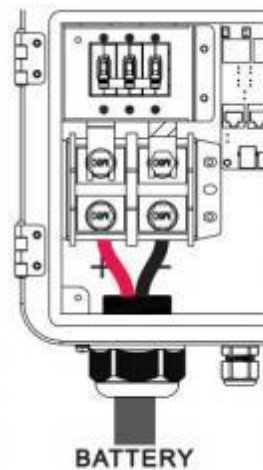

### **⚠ DANGER**

- Before connecting battery, the circuit breaker must be opened to avoid the risk of electric shock and must not be operated with electricity.
- Make sure that the positive and negative terminals of the battery are connected correctly and not reversed, otherwise the inverter may be damaged.
- Please check that the cable used is sufficient for the requirements, too thin, poor quality.
- cables are a serious safety hazard.

## 4.5 PV connection

Connect the positive and negative wires of both PVs in the cable locations and sequence shown in the diagram below. The positive wire runs through the AFCI unit.

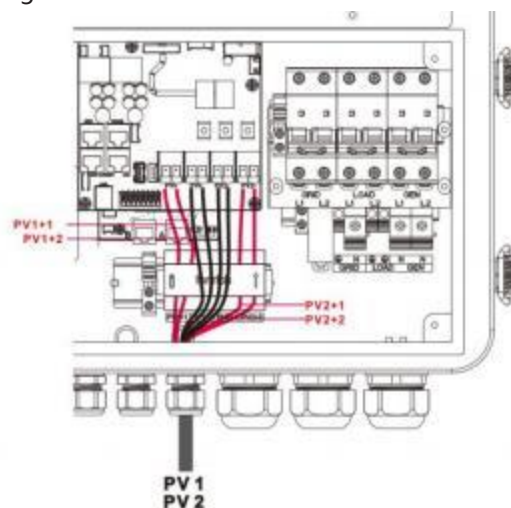

**⚠ DANGER**

- Before connecting the PV, the circuit breaker must be disconnected to avoid the risk of electric shock and must not be energized.
- Make sure that the open-circuit voltage of the PV modules connected in series does not exceed the maximum open-circuit voltage of the inverter (the value is 550V), otherwise the inverter may be damaged.

## 4.6 Dry contact connection

Use a small screwdriver to push back the direction indicated by the arrow, then insert the communication cable into the dry junction port. (Communication cable diameter 0.2~1.5mm<sup>2</sup>)

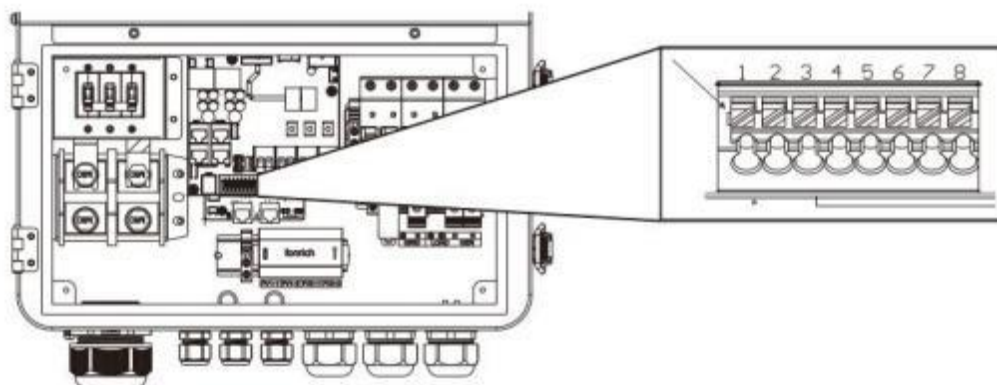

## 4.7 Grounding connection

Please make sure the grounding terminal connect to the Grounding Bar.

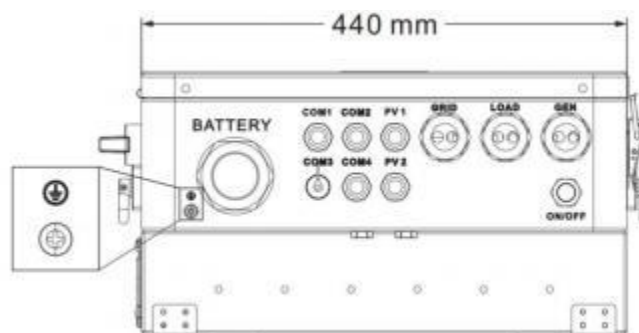

**ⓘ NOTICE**

- The grounding cable should have a diameter of not less than 4 mm<sup>2</sup> and be as close as possible to the grounding point.



## 4.8 Final assembly

After ensuring that the wiring is reliable and the wire sequence is correct, install the terminal protection cover in place.

- **Step 1** : Close the circuit breaker of the battery.
- **Step 2** : Press the rocker switch on the bottom of inverter, the screen and indicators light up to indicate that the inverter has been activated.
- **Step 3** : Sequential close of the circuit breakers for PV, AC input and AC output.
- **Step 4** : Start the loads one by one in order of power from small to large

## 4.9 Start up the inverter

### 4.9.1 Introduction

1. Up to six units connected in parallel.
2. When using the parallel operation function, the following connecting lines (package accessories) shall be firmly and reliably connected:

**Parallel communication line\*1**



### 4.9.2 Precautions for connecting the parallel connecting lines

**Warning** 

#### 1.PV connection:

When connected in parallel, the PV arrays of each machine must be independent and the PV arrays of PV1 and PV2 of each machine must also be independent.

#### 2.Battery wiring:

Parallel connection in single or three-phase: ensure that all solar storage inverters are connected to the same battery, with BAT + connected to BAT + , BAT - connected to BAT - , and that the connection is correct with the same wiring length and line diameter before power on, so as to avoid the abnormal operation of parallel system output caused by wrong connection.

#### 3.LOAD wiring:

When connecting the parallel machine, all the inverse control integrated machine must be connected to L and L, N and N line connected, PE and PE connected, and ensure that the power on and off before connecting correctly and the wiring length and wire diameter is the same, to avoid connecting incorrectly caused by the output of the parallel system does not work properly.

When connecting three-phase parallel machines, all inverse control integrated machines must be connected N to N wire and PE to PE. The L lines of all machines in the same phase need to be connected together, but the L lines of AC outputs of different phases cannot be connected together. Other precautions are the same as single-phase connection of parallel machines.

#### 4.GRID wiring:

connection for all solar storage

inverters, and that the connection is correct with the same wiring length and line diameter before power on, so as to avoid the abnormal operation of parallel system output caused by wrong connection. Meanwhile, it is not allowed to have multiple different AC source inputs to avoid damage to the external equipment of the inverter. The consistency and uniqueness of AC source input shall be ensured.

Parallel connection in three-phase: ensure N-to-N and PE-to-PE connection for all solar storage inverters. The L lines of all inverters connected to the same phase need to be connected together. But L lines of different phases cannot be joined together. Other connection precautions are the same as parallel connection in single phase.

**5.Wiring of parallel communication line:**

Our parallel communication cable is a shielded 10Pin network connection cable, which can be used for single-phase or three-phase parallel connection. Each machine must be connected with one out and one in. This means that the machine "Parallel\_A" is connected to the machine to be parallelized "Parallel\_B", and that the machine "Parallel\_A" is not allowed to connect to the "Parallel\_B". "Parallel\_B" or "Parallel\_A" is connected to the machine to be parallelized "Parallel\_A". At the same time, the parallel communication cable of each machine should be fastened with 10Pin network connection cable to avoid disconnection or poor contact of the parallel communication cable, which may cause abnormal operation or damage to the system output.

6.Before and after connecting the system, please check the following system wiring diagrams in detail to ensure that all wiring is correct and reliable before powering on.

7.After the system is wired, powered on and in normal operation, if a new inverter needs to be connected, make sure to disconnect the battery input, PV input, AC input and AC output, and that all solar storage inverters are powered off before reconnecting into the system

**4.9.3 Split-phase parallel connection**

Setting for each inverter: Select "Parallel" for parallel mode, select "Split Phase" for grid type, when "120V" is selected for output phase voltage, the output L1-L2 voltage is 240V, L1-N voltage is 120V, L2-N voltage is 120V.

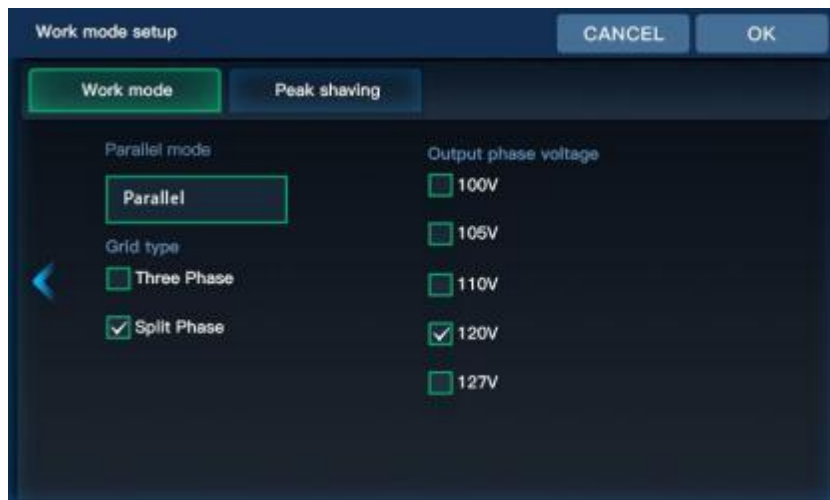

The wiring diagram is shown below:

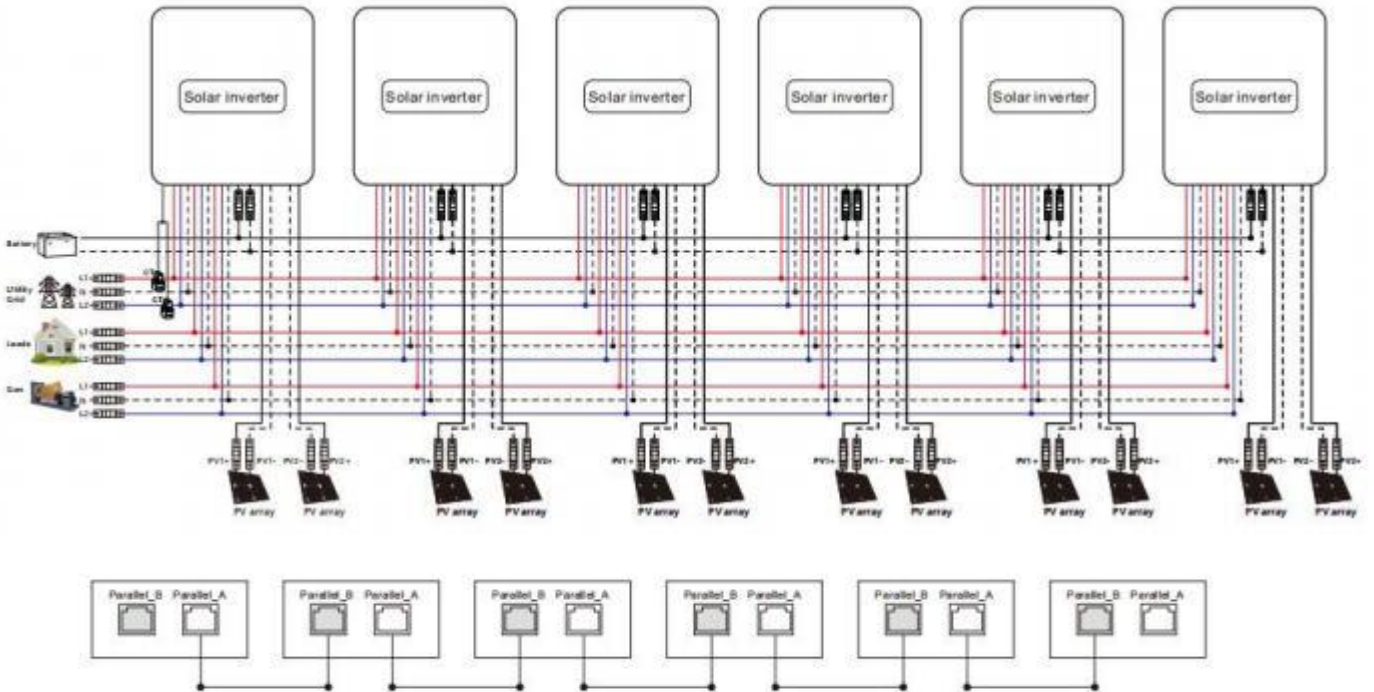
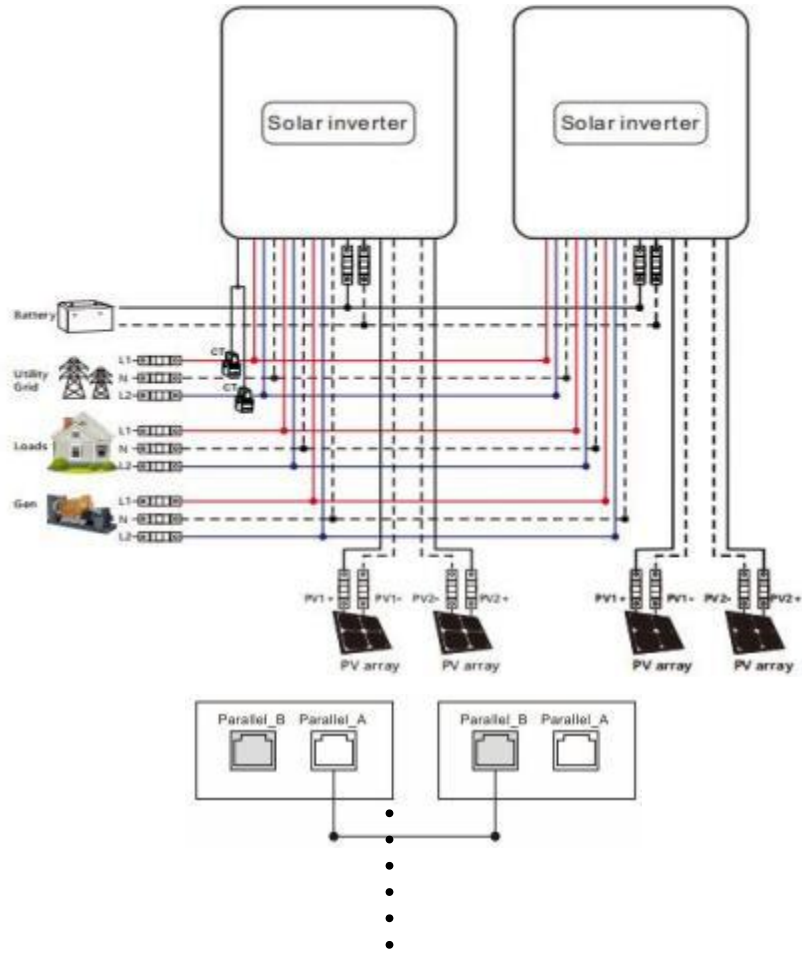

## 4.9.4 Three-phase parallel connection

(1) 2 inverters connected in parallel to form a three-phase output (three-phase unbalanced)

**P1 machine setting:** Parallel mode select "Three phase A", grid type select "Three Phase", when output phase voltage select "120V" When "120V" is selected for output phase voltage, the output L1-L2 voltage is 208V, L1-N voltage is 120V, L2-N voltage is 120V.

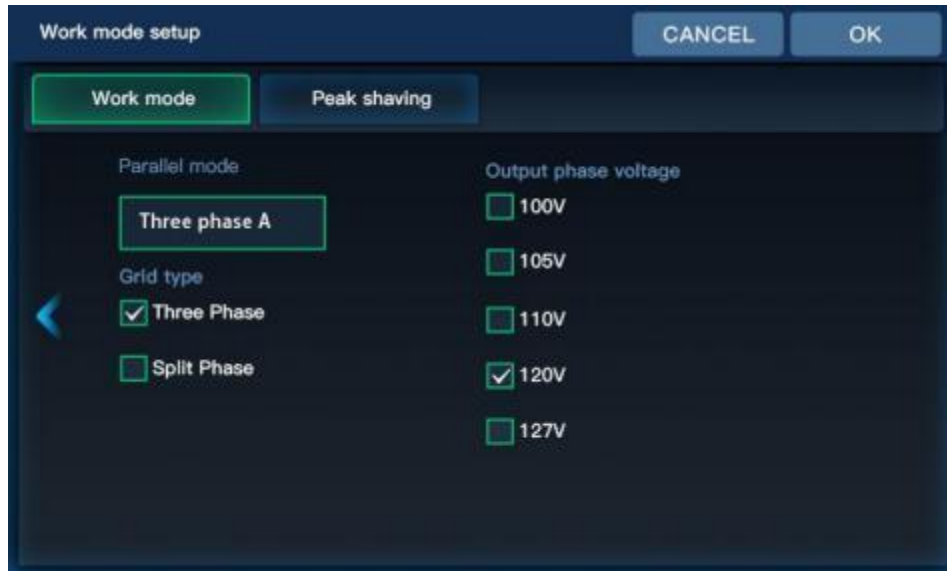

**P2 machine setting:** Parallel mode select "Three phase B", grid type select "Three Phase", when the output phase voltage select "120V", then the output L1-L2 voltage is 208V, L1-N voltage is 120V, L2-N voltage is 120V. When "120V" is selected for output phase voltage, the output L1-L2 voltage is 208V, L1-N voltage is 120V, L2-N voltage is 120V.



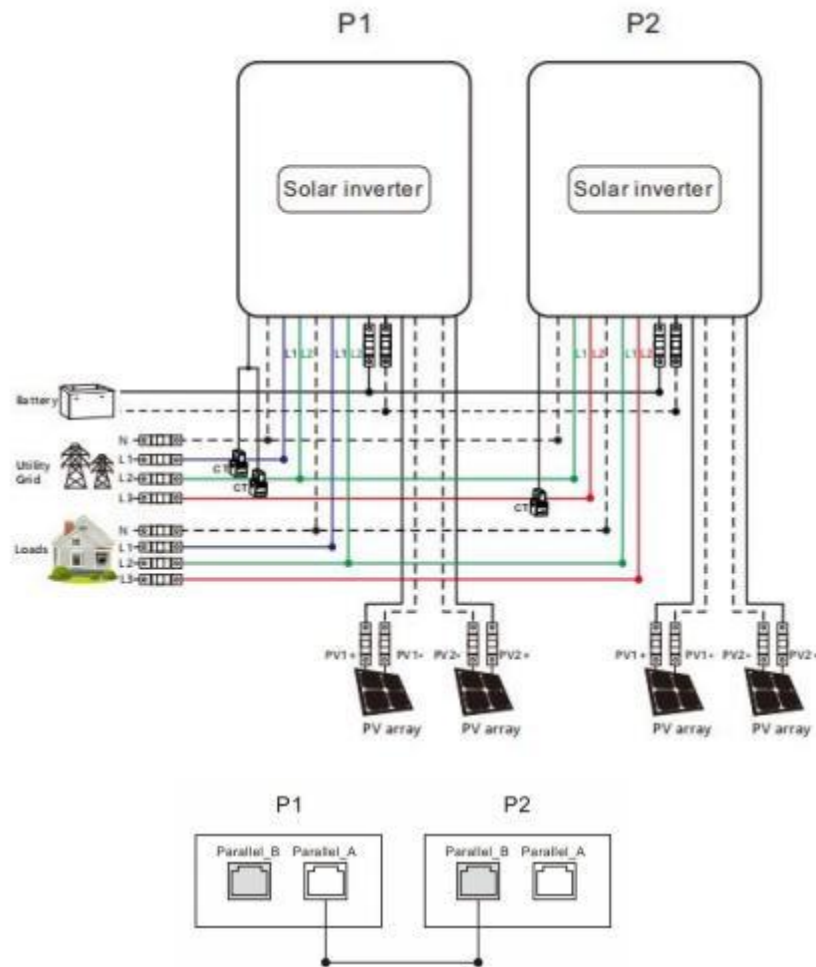

(2)3 or 6 inverters in parallel to form a three-phase output (three-phase balanced)

**P1 machine setting:** Parallel mode select "Three phase A", grid type select "Three Phase", when output phase voltage select "120V" When "120V" is selected for output phase voltage, the output L1-L2 voltage is 208V, L1-N voltage is 120V, L2-N voltage is 120V.

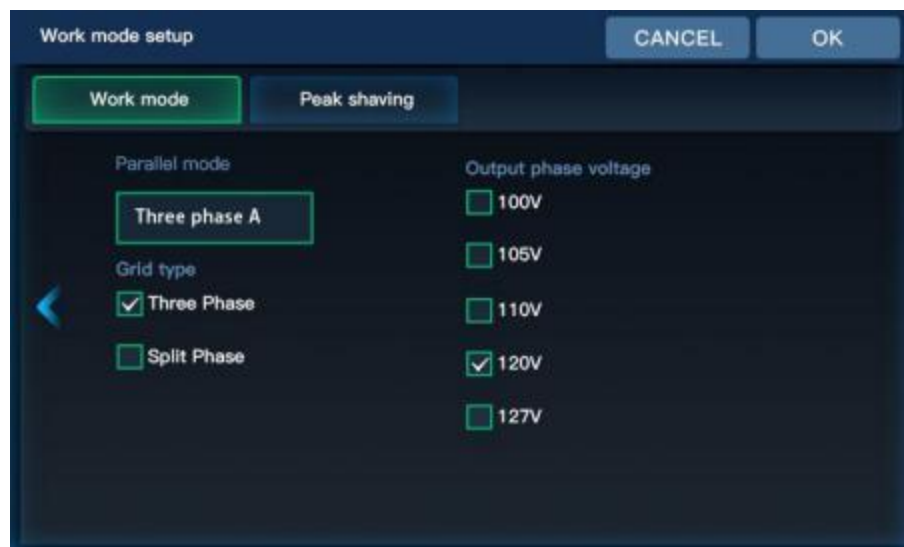

**P2 machine setting:** Parallel mode select "Three phase B", grid type select "Three Phase", when the output

hase voltage select "120V", then the output L1-L2 voltage is 208V, L1-N voltage is 120V, L2-N voltage is 120V. When "120V" is selected for output phase voltage, the output L1-L2 voltage is 208V, L1-N voltage is 120V, L2-N voltage is 120V.

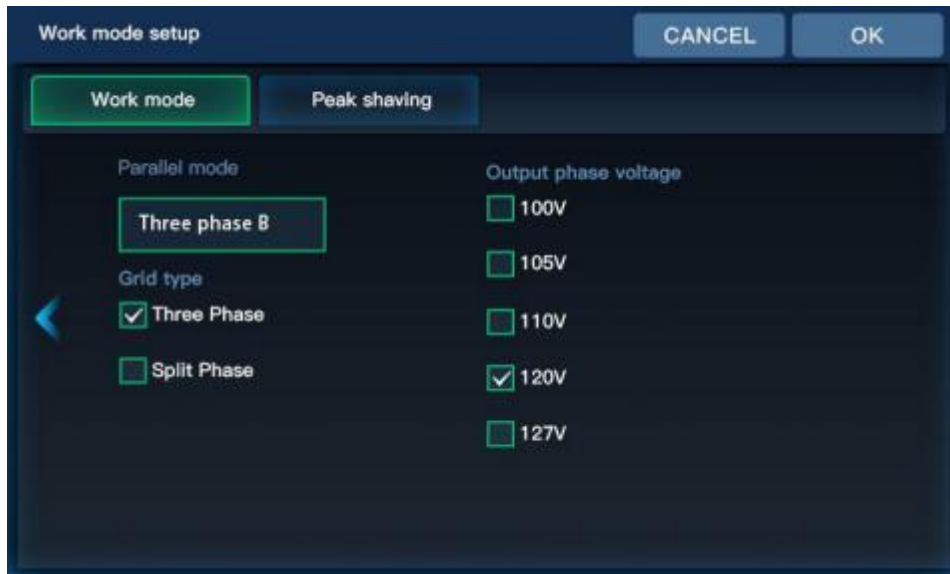

**P3 machine setting:** Parallel mode select "Three phase C", grid type select "Three Phase", when output phase voltage select "120V", then output L1-L2 voltage is 208V, L1-N voltage is 120V, L2-N voltage is 120V. When "120V" is selected for output phase voltage, the output L1-L2 voltage is 208V, L1-N voltage is 120V, L2-N voltage is 120V.

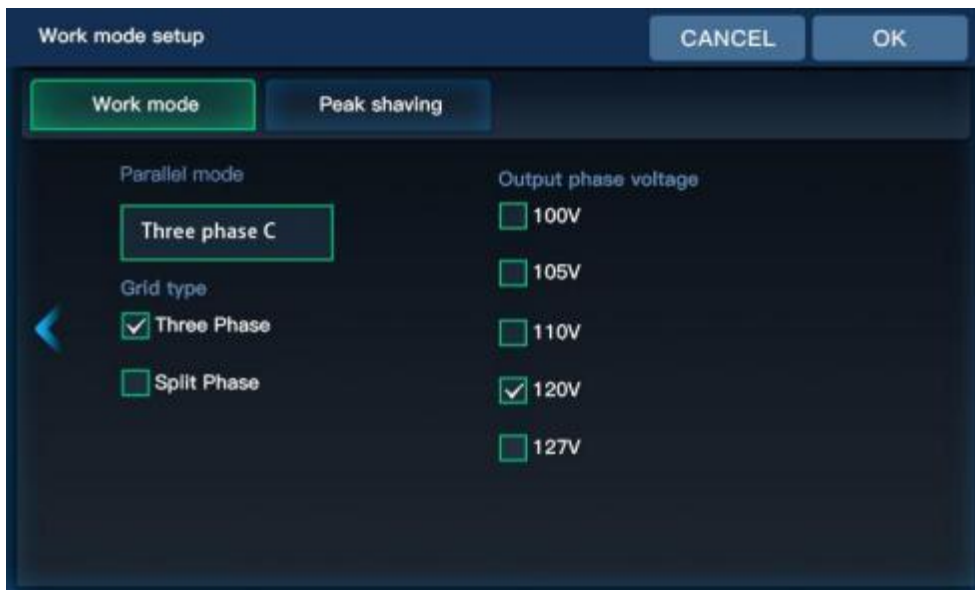

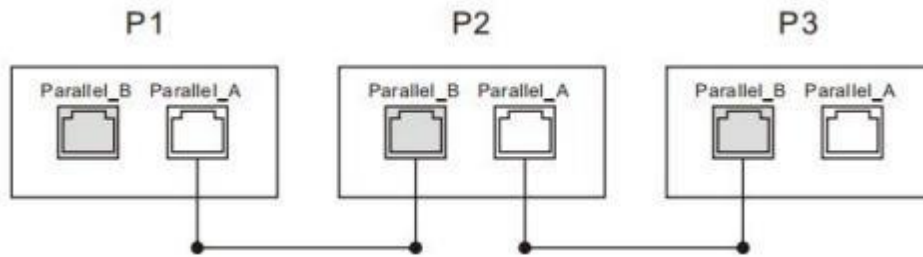
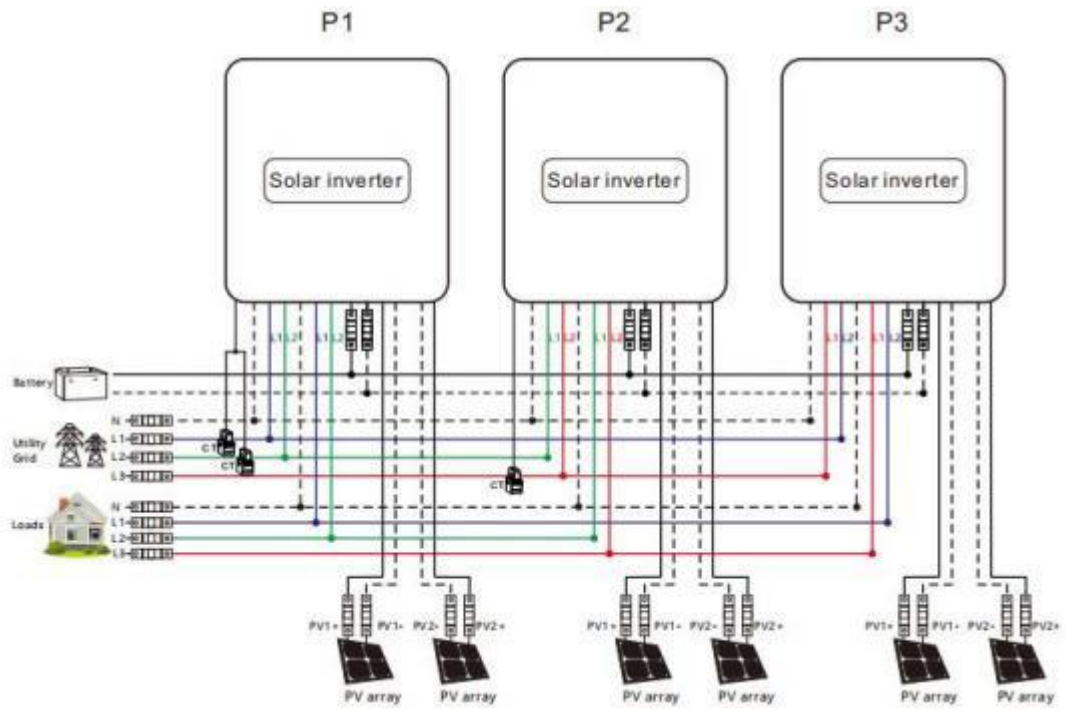

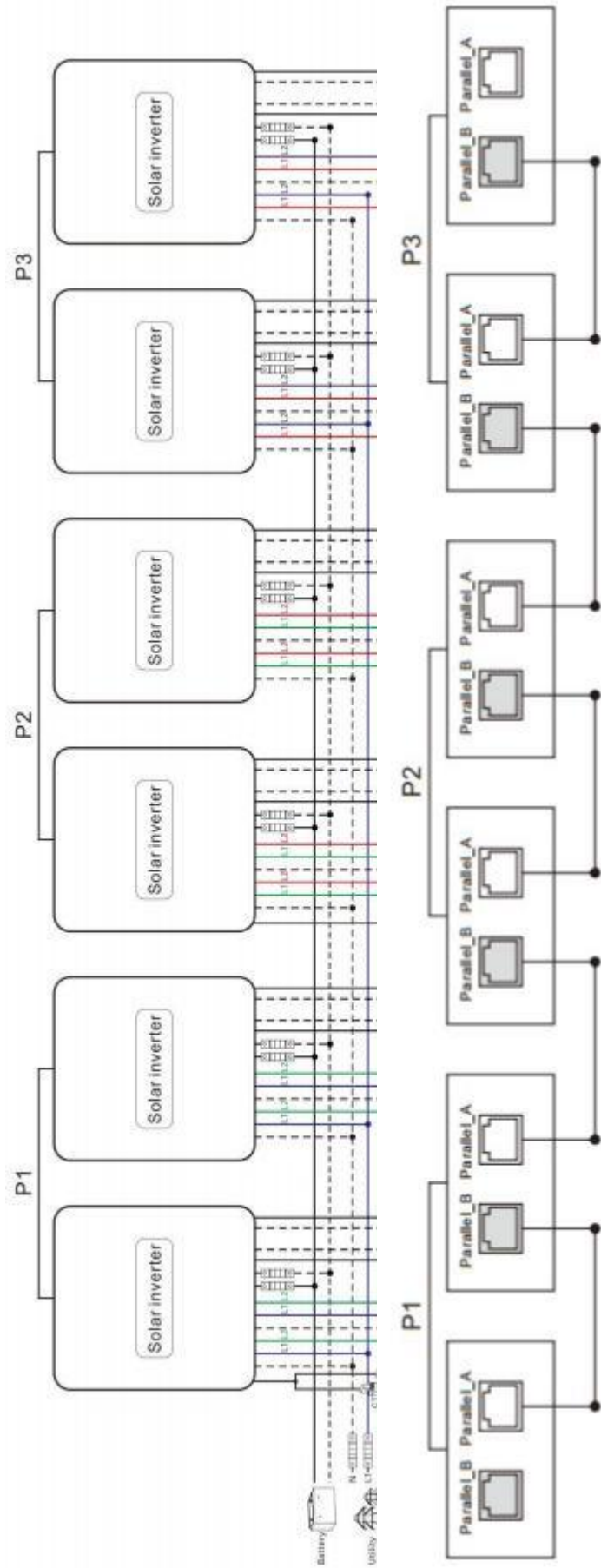



## 5. Operation

### 5.1、 Operation and display panel

The operation and display panel below includes 1 LCD screen, 3 indicators, 4 Mechanical keys

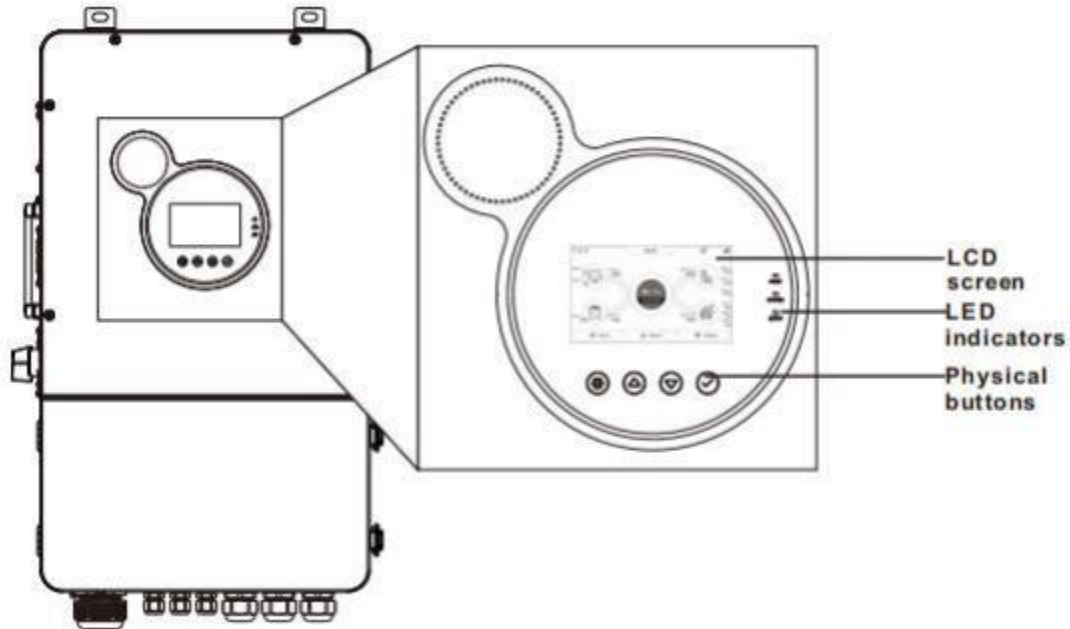

#### Mechanical keys

| Mechanical keys | Description                                    |
|-----------------|--|
|                 | To enter/exit the setting menu                 |
|                 | To last selection                              |
|                 | To next selection                              |
|                 | To confirm/enter the selection in setting menu |

#### LED indicators









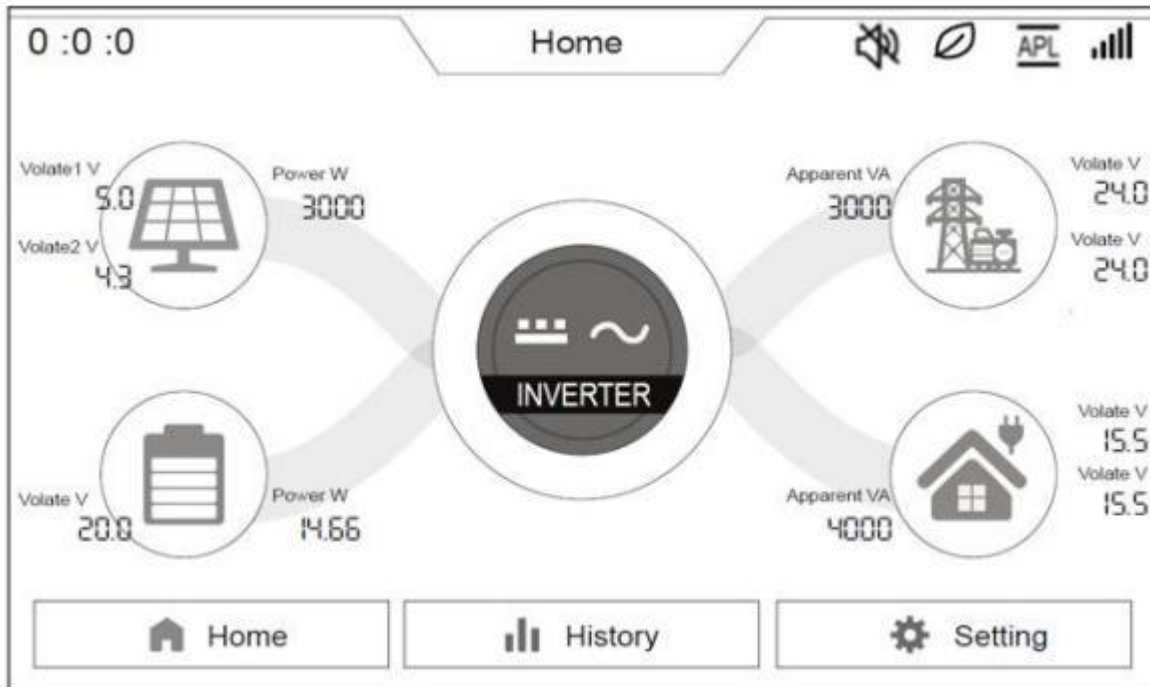





**Yellow light for inverter Green light for charging**

| Indicators | Color  | Description                            |
|------------|--------|--|
| FAULT      | Red    | Flash: error occur                     |
| CHARGE     | Green  | Continued: charging complete           |
|            |        | Flash: charging                        |
| AC/INV     | Yellow | Continued: utility grid by-pass output |

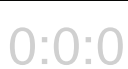
|  |  |                        |
|--|--|------------------------|
|  |  | Flash: inverter output |
|--|--|------------------------|

 **Display panel**

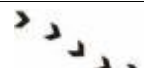

| Icon  | Description            | Icon   | Description          |
|---|------------------------|--|----------------------|
|  | Solar panel            |   | Load                 |
|  | Battery                |   | Grid                 |
|  | Home page              |   | Generator            |
|  | History data           |   | Inverter is Working  |
|  | Local time             |  | Setting              |
|  | BMS communicate status |   | Energy Saving Mode   |
|  | The energy direction   |   | The buzzer is silent |

## View real-time data

On the LCD home screen, click the inverter icon, battery icon, mains icon, load icon and photovoltaic icon to view the real-time data of the machine.

| System data  |  |     |                               |
|--------------|--|-----|-------------------------------|
| No.          | Item   | No. | Item                          |
| 1            | Machine state  | 8   | SN                            |
| 2            | MCU1 version   | 9   | Min version number            |
| 3            | LCD version  | 10  | Rated power                   |
| 4            | MCU2 version   | 11  | RS485 Address                 |
| 5            | Outside Temperature                                    | 12  | Transformer temperature       |
| 6            | L1 Voltage   | 13  | L1 Current                    |
| 7            | L2 Voltage   | 14  | L2 Current                    |
| Battery data |  |     |                               |
| 1            | SOC (Percentage of remaining battery capacity)         | 5   | Discharge current             |
| 2            | Battery voltage  | 6   | BMS protocol                  |
| 3            | Battery current  | 7   | Battery type                  |
| 4            | Battery power (Battery charging and discharging power) | 8   | Battery Charge Status         |
| Grid data    |  |     |                               |
| 1            | L1 Voltage V   | 7   | L2 Voltage                    |
| 2            | L1 Current A   | 8   | L2 Current                    |
| 3            | L1 active power  | 9   | L2 active power               |
| 4            | L1 apparent power                                      | 10  | L2 apparent power             |
| 5            | Frequency  | 11  | Mains charging current        |
| 6            | CT power   |     |                               |
| Load data    |  |     |                               |
| 1            | L1 Voltage   | 8   | L2 Voltage                    |
| 2            | L1 Current   | 9   | L2 Current                    |
| 3            | L1 UPS load active power                               | 10  | L2 UPS load active power      |
| 4            | L1 UPS load apparent power                             | 11  | L2 UPS load apparent power    |
| 5            | Frequency  | 12  | load factor                   |
| 6            | BUS Voltage  | 13  | L2 Home load power            |
| 7            | L1 Home load power                                     |     |                               |
| PV data      |  |     |                               |
| 1            | PV1 voltage V  | 5   | PV2 current                   |
| 2            | PV1 current A  | 6   | PV2 power                     |
| 3            | PV1 power W  | 7   | Generate energy total ( kWh ) |
| 4            | PV2 voltage V  |     |                               |

## 5.2、 Setting

**Operating instructions:** Click on the settings in the menu bar at the bottom of the screen to enter the setup interface, including the basic settings, operating mode settings, battery settings, grid settings, advanced settings of the five major setup items

### 5.2.1 Basic Setup

#### 5.2.1.1 Display Setup

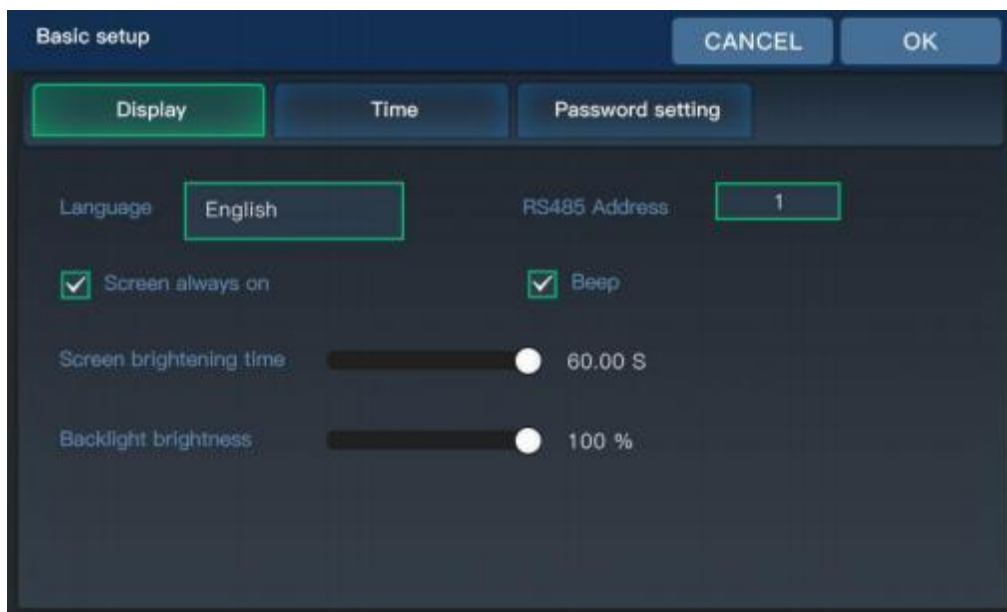

| Parameter Meaning       | Description   |
|-------------------------|---|
| Language                | Currently only English                                  |
| RS485 Address           | Display and current inverter RS485 address, range 1-255 |
| Screen always on        | Selectable whether the screen is always on or not       |
| Beep                    | You can choice whether enable the Beep alarm            |
| Screen brightening time | Setting range 0-60S                                     |
| Backlight brightness    | 0-100%  |

### 5.2.1.2. Time Setup

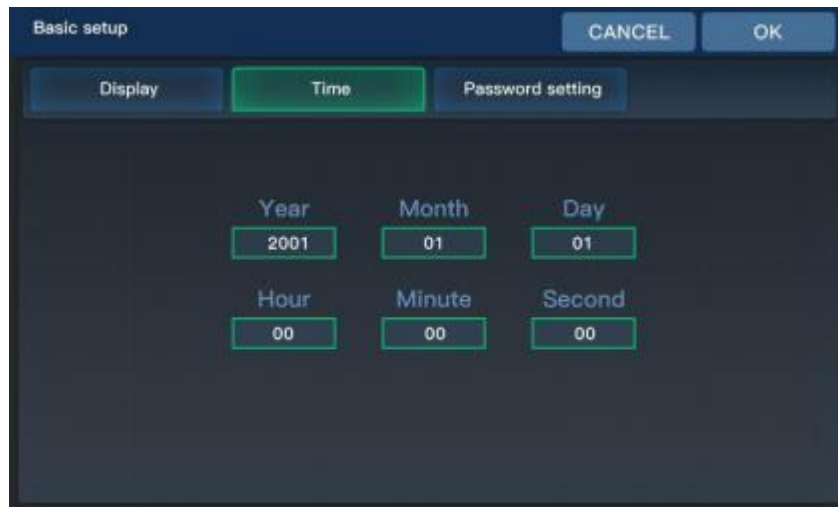

### 5.2.1.3. Password Setting ( Password is required to access the Grid Settings and Advanced Settings )

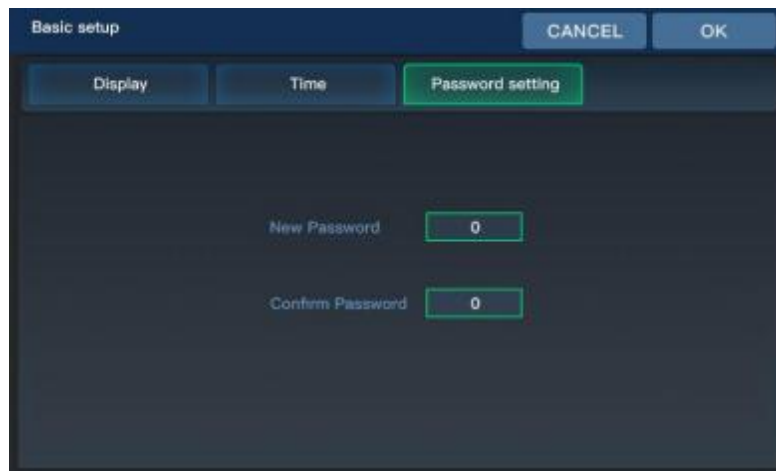

Default password is "00000".

Password setting value range: 0-65535

## 5.2.2 Work Mode Setup

### 5.2.2.1. Work Mode

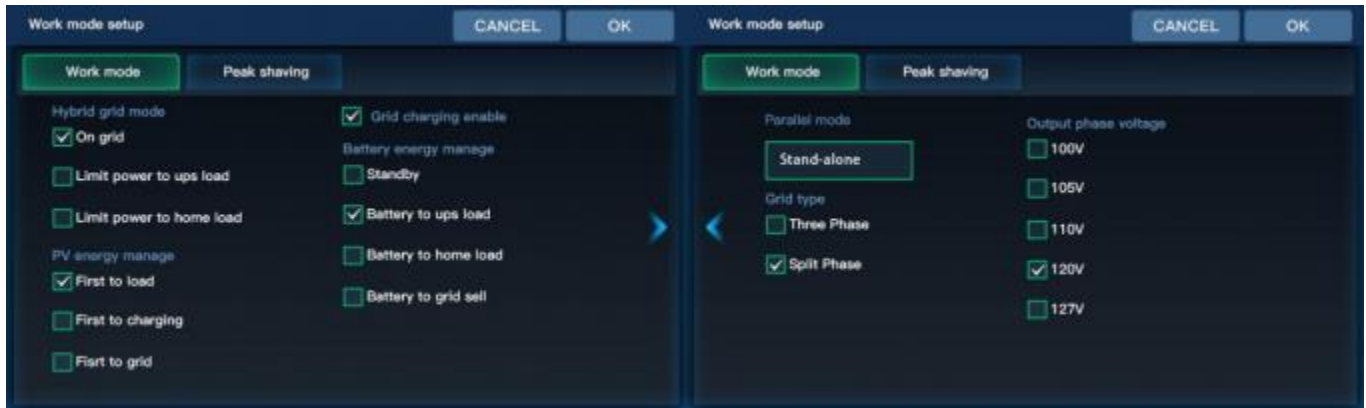

Home Load: connected to the GRID port of the machine, requires external CT for monitoring.

Ups Load: connected to the LOAD port of the machine.

| Parameter Meaning     | Option               | Description  |
|-----------------------|----------------------|--|
| Hybrid grid mode      | On grid              | Direct grid connection of excess PV energy   |
|                       | Limit Power to ups   | Ups load backflow prevention, photovoltaic or battery energy is only for the ups load, excess energy will not be connected to the grid   |
|                       | Limit Power to home  | Home load anti-backflow, solar or battery energy is only supplied to the home load, excess energy will not be connected to the grid.   |
| PV energy manage      |                      | <ul style="list-style-type: none"> <li>☞ When mixed grid mode is set to "Limit Power to ups load" or when CT is not connected, the following load refers to the ups load.</li> <li>☞ When mixed grid mode is set to "Limit Power to home load/On grid" and CT is connected, the following load refers to the ups load plus the home load.</li> </ul> |
|                       | First to Load        | PV power supply logic: load-charge-grid connection   |
|                       | First to charging    | PV power supply logic: charge-load-grid connection   |
|                       | First to grid        | PV power supply logic: load-grid connection-charge   |
| Grid charging enable  |                      | Selectable grid participation in battery charging  |
| Battery energy manage | Standby              | The battery does not discharge, and the battery is discharged only when the working state is off the grid.   |
|                       | Battery to ups load  | When the PV power is less than the UPS load power, the battery discharge is added.   |
|                       | Battery to home load | The battery can supply the power to Home load  |
|                       | Battery to grid sell | The battery can supply the power to grid.  |
| Parallel mode         | Stand-alone          |  |
|                       | Parallel             | The grid type setting is effective when set to split-phase.  |
|                       | Three Phase A        | The grid type setting is effective when set to three-phase.  |
|                       | Three Phase B        |  |
|                       | Three Phase C        |  |

|                      |                                     |  |
|----------------------|-------------------------------------|--|
| Grid type            | Three Phase                         | When the grid type is three-phase, the phase difference between L1 and L2 is 120° and the output voltage is 120V/208V  |
|                      | Split Phase                         | When the grid type is split-phase, the phase difference between L1 and L2 is 180°, and the grid voltage is 120 V/240 V. Please select according to the actual grid type. |
| Output phase voltage | Settable : 100V,105V,110V,120V,127V |  |

### 5.2.2.2. Peak Shaving



| Parameter Meaning                    | Description  |
|--------------------------------------|--|
| Time charging/<br>discharging enable | Select whether to turn on timed charging and discharging   |
| Start/End Time                       | Setting the time period for timed charging and discharging   |
| Stop SOC                             | Setting the battery charging cut-off SOC value and the cut-off SOC value for discharging during the timed charging and discharging time period (during BMS communication)          |
| Stop Volt                            | Setting the battery charging cut-off voltage value and discharging cut-off voltage value during the timed charging and discharging time period (when the BMS is not communicating) |
| Max Power                            | Setting the battery charging power and discharging power during the timed charging and discharging time period   |

## 5.2.3 Battery setup

### 5.2.3.1. Battery Type

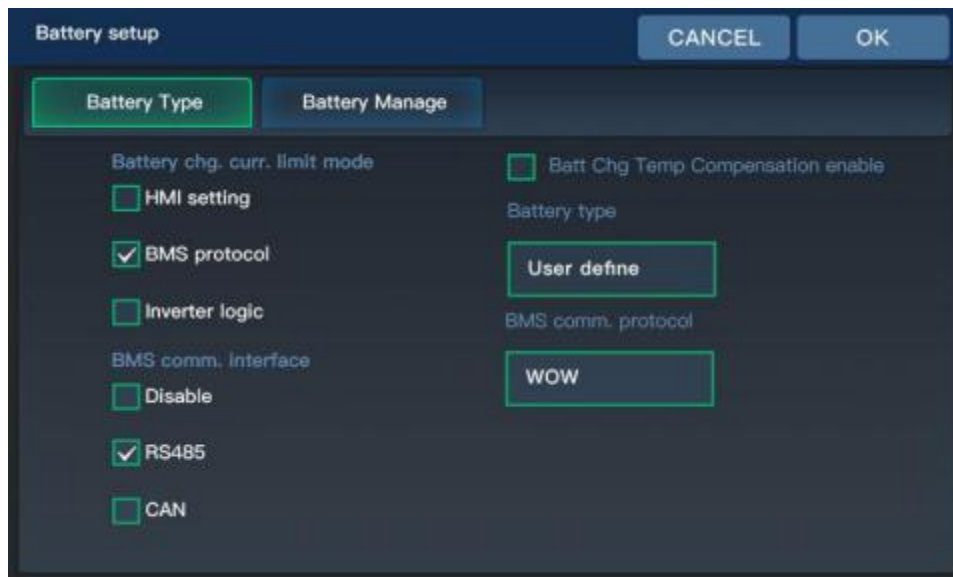

| Parameter Meaning   | Option   | Description   |
|---|--|---|
| Battery chg. curr. limit<br>( Valid for BMS communication ) | HMI  | Maximum battery charging current is limited according to the inverter battery charging current setting value. |
|   | BMS  | Maximum battery charging current is limited by the current limit value of the BMS.                            |
|   | Inverter   | Maximum battery charging current is limited by the machine's derating logic.                                  |
| BMS comm. interface   | Disable  | BMS does not communicate  |
|   | RS485  | BMS RS485 communication function  |
|   | CAN  | BMS CAN communication function  |
| Battery Temperature Compensation                            | Select whether to turn on temperature compensation   |   |
| Battery Type  | USER   | User customizable to set all battery parameters   |
|   | SLd  | Sealed Lead Acid Battery  |
|   | FLd  | Open-ended lead-acid batteries  |
|   | GEL  | gel lead-acid battery   |
|   | LFP/14/ 15/<br>LFP 16  | Li-FePO4/14/15/16, corresponding to Li-FePO4 14 string, 15 string, 16 string                                  |
|   | N13/ N14   | Ternary lithium batteries, N13/N14, corresponding to ternary lithium batteries 13 string, 14 string           |
|   | No battery   | Without battery   |
| BMS comm.protocol   | When the BMS port selection setting item = 485 or CAN, you need to select the corresponding lithium battery manufacturer brand for communication:<br>1 : PACE-PACEEX 2 : RUDA-Ritar 3 : AOGUAN=ALLGRAND BATTERY 4 : OULITE-OLITER<br>5 : CEF-CHANGFENG TECHNOLOGY 6 : XINWANGDA -SUNWODA 7 : DAQIN -DAKING 8 : WOW-SRNE<br>9 : PYL-PYLONTECH 10 : MIT-FOXESS 11: XIX-XYE 12: POL-POWERMR 13: GUOX-Gotion<br>14: SMK-SMK 15: VOL-WEILAN 16:UZE-YUZE |   |

### 5.2.3.2. Battery Manage





| Parameter Meaning           | Description  |
|-----------------------------|--|
| Maximum chg.voltage         | When the battery is charging, the voltage reaches the value to stop charging   |
| Batt. Recharging voltage    | When the battery is fully charged, the inverter stops charging and resumes charging when the battery voltage falls below this voltage value.   |
| Battery curr. stop chg.     | Charging stops when the charging current falls below this setting.   |
| Stop discharge Voltage      | When the battery is discharged, the voltage reaches the value and stops discharging.   |
| Eod recovery voltage        | When the battery low voltage disconnects the inverter output, the battery voltage needs to be greater than this setting to restore the battery inverter AC output.   |
| Battery under volt. alarm   | Battery under-voltage alarm point, when the battery voltage is lower than the judgment point, the under-voltage alarm will be reported and the output will not be turned off.                              |
| Maximum chg. current        | Setting the amount of current when charging the battery  |
| Max. chg. curr. by Grid     | When using mains charging, set the size of the battery mains charging current (the value is the battery current, DC)   |
| Bat.SOC stop chg.           | "Charging will stop when the SOC value reaches this set point (effective when BMS communication is normal)."   |
| stop. dchg. delay time      | When the battery voltage reaches the "Stop Discharge Voltage" setting, the inverter output is shut down with a delay.  |
| Batt. SOC stop dchg.        | When the SOC value reaches this setting, an error 32 is reported and the inverter output is shut down (valid when BMS communication is normal).  |
| Batt SOC low alarm          | SOC value up to this setting will report 30 faults. The inverter output will not shut down and the fault disappears if the SOC value exceeds 5% of the set value. (Valid when BMS communication is normal) |
| Batt.volt.stop dchg to grid | When the battery reaches the voltage value, it switches to the grid supply   |
| Batt.soc.stop dchg to grid  | When the battery reaches the SOC value, it is converted to mains power supply (effective for BMS communication).   |

## 5.2.4 On grid setup

To enter this setting, you need to enter the password set by the user, the default password is "00000".

### 5.2.4.1. Basic



| Parameter Meaning                 | Description  |
|-----------------------------------|--|
| Grid Standard                     | USA : UL1741&IEEE1547.1-2020   |
|                                   | California, USA:RULE21   |
|                                   | Hawaii, USA:HECO   |
|                                   | Other regions:GNL  |
| Grid Frequency                    | Selection of local grid frequency , 50Hz/60Hz  |
| CT ratio                          | When connecting an external CT, enter the ratio on the CT specification.   |
| Sell power Max                    | On grid power  |
| Buy power Max                     | Maximum power drawn from the grid. If the grid charging power + load power exceeds this setting, the machine reduces the charging power. (Setting range: 0 to rated power) |
| Zero-export power                 | Error calibration power in the case of backflow prevention, recommended setting 20-100W  |
| On-Grid Reactive Power            | Setting range 0-100%, % of reactive power  |
| Reactive power over/under excited | Over indicates 0%-100% / Under indicates -100%-0%  |
| On Grid PF                        | Setting range 0.8-1  |
| Power factor over/under excited   | Over indicates 0.8-1 / Under indicates -0.8 - -1   |

### 5.2.4.2. Enter Service(This setting is not recommended to be changed by the customer)



| Parameter Meaning              | Description   |
|--------------------------------|---|
| Enter Service enable           | Grid-connect enable setting (on by default)                               |
| Connect Voltage Low            | Grid-connected low voltage protection voltage                             |
| Connect Frequency Low          | Grid-connected low-frequency protection points                            |
| Connect Voltage High           | Grid-connected high-voltage protection voltage                            |
| Connect Frequency High         | Grid-connected high-frequency protection points                           |
| Normal connect delay time      | Grid normal connection, grid connection delay time                        |
| Normal connect Power Ramp Rate | Normal grid connection, rate of rise of grid-connected power              |
| Reconnect delay time           | Grid down reconnection, grid connection delay time                        |
| Reconnect Power Ramp Rate      | Grid disconnection and reconnection, rate of rise of grid-connected power |

**5.2.4.3. Grid Protection (This setting is not recommended to be changed by the customer)**



| Parameter Meaning | Description                             |
|-------------------|---|
| LV1               | Class 1 undervoltage protection point   |
| LF1               | Class 1 underfrequency protection point |
| LV2               | Class 2 undervoltage protection point   |
| LF2               | Class 2 underfrequency protection point |
| HV1               | Class 1 overvoltage protection point    |
| HF1               | Class 1 overfrequency protection point  |
| HV2               | Class 2 overvoltage protection point    |
| HF2               | Class 2 overfrequency protection point  |
| Time              | Protection Response Time                |

#### 5.2.4.4. Other

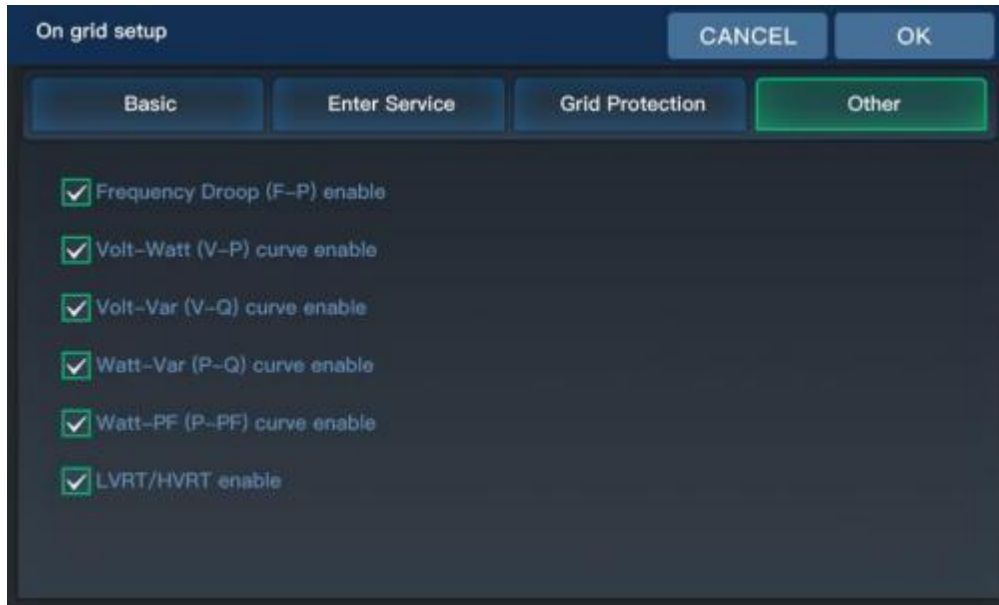

| Parameter Meaning              | Description  |
|--------------------------------|--|
| Frequency Droop ( F-P ) enable | Adjustment of inverter output power according to grid frequency                  |
| Volt -Watt (V-P) curve enable  | Adjustment of the inverter active power according to the set grid voltage        |
| Volt-Var (V-Q) curve enable    | Adjustment of the inverter reactive power according to the set grid voltage      |
| Watt-Var (P-Q) curve enable    | Adjustment of the inverter reactive power according to the set active power      |
| Watt-PF (P-PF) curve enable    | Adjustment of the power factor of the inverter according to the set active power |
| LVRT/HVRT enable               | Adjustment of grid HV ride-through / LV ride-through values                      |

## 5.2.5 Advance Setup

To enter this setting, you need to enter the password set by the user, the default password is "00000".

### 5.2.5.1. Generator

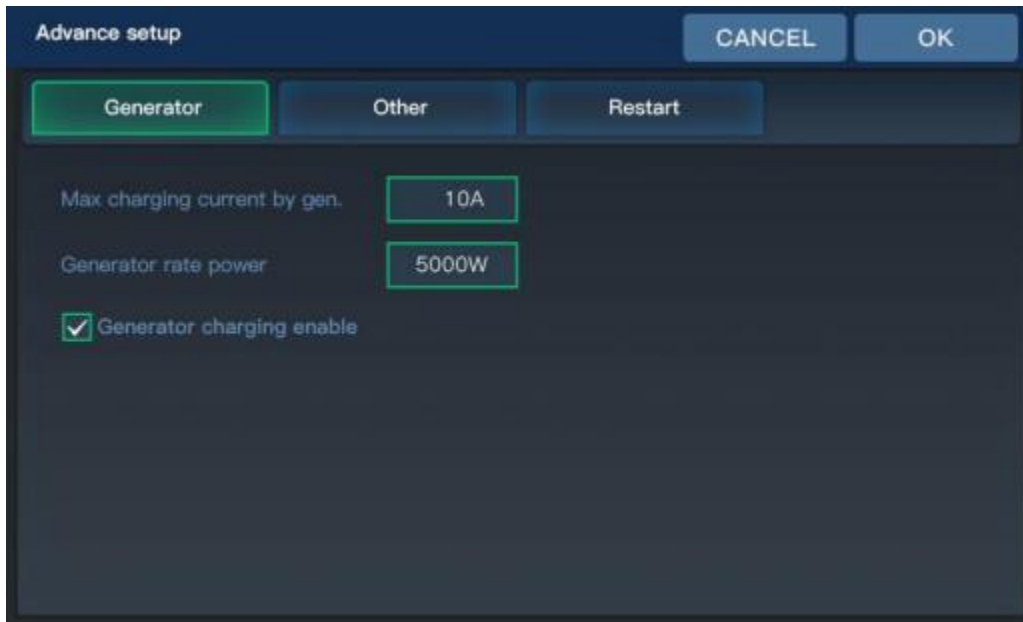

| Parameter Meaning            | Description  |
|------------------------------|--|
| Max charging current by gen. | Maximum battery charging current during generator charging               |
| Generator rate power         | Setting the power of the generator up to the rated power of the inverter |
| Generator charging enable    | Setting whether the generator is charged or not                          |

### 5.2.5.2. Other

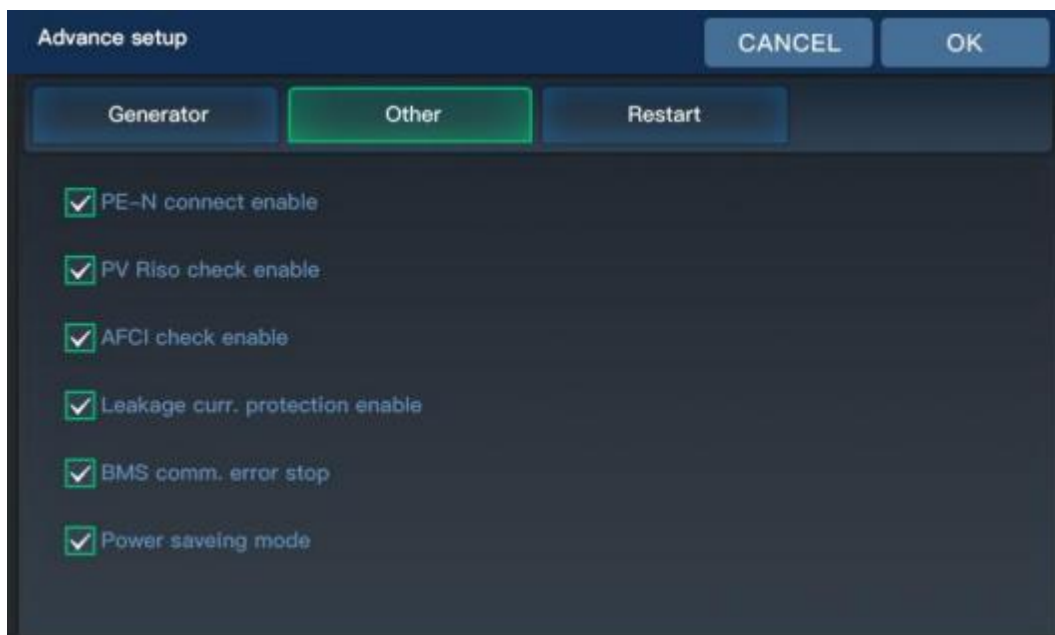

| Parameter Meaning               | Description   |
|---------------------------------|---|
| PE-N connect enable             | Enable automatic switching of PE-N connections  |
| PV Riso check enable            | Enable PV insulation impedance detection  |
| AFCI check enable               | Turn on AFCI check  |
| Leakage curr. protection enable | Enable leakage current protection   |
| BMS comm. error stop            | After turning on, the inverter output turns off when the machine reports 58 communication faults  |
| Power saveing mode              | After turning on the energy-saving mode, if the load is empty or less than 25W, the inverter output will be shut down after a delay of 5min; when the load is more than 40W, the inverter will start automatically. |

### 5.2.5.3. Restart

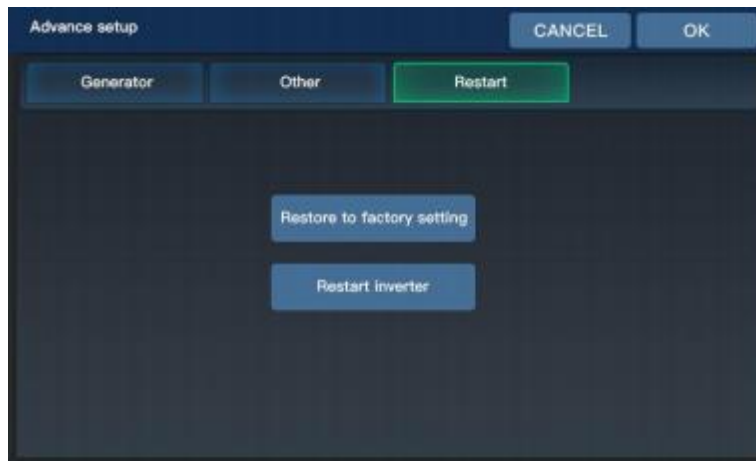

| Parameter Meaning        | Description                 |
|--------------------------|-----------------------------|
| Restore Factory Settings | Reset all inverter settings |
| Reboot Inverter          | Restart the inverter        |

## 5.3、 Time-slot charging/discharging function

SEI series has the function of charging and discharging in different time periods, users can set different charging and discharging time periods according to the local peak and valley electricity price, so that the utility power and photovoltaic energy can be reasonably utilized.

When the utility price is expensive, the battery inverter can be used to supply power to the load; When the utility price is cheap, the utility can be used to supply and charge the load, which can maximize the user's savings in electricity costs.

Users can turn on/off the time-sharing charging/discharging function in the Setup menu parameters Segmented Charging Enable and Segmented Discharging Enable, and set the charging and discharging time periods in the parameters Timed Utility Charging Start/Time Settings and Timed Utility Discharging Start/Time Settings. Below is a case example to help users understand the function.

### NOTICE

Before using this function for the first time, please set the local time and date, and then users can set the corresponding time slots according to the local peak and valley tariff charges.

Peak-Valley Electricity Tariff

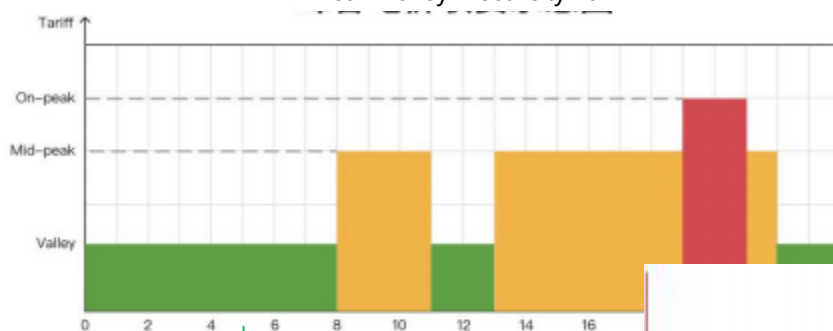

#### Time-slot Utility Charging/Carrying

#### Time-slot Battery Discharging Function

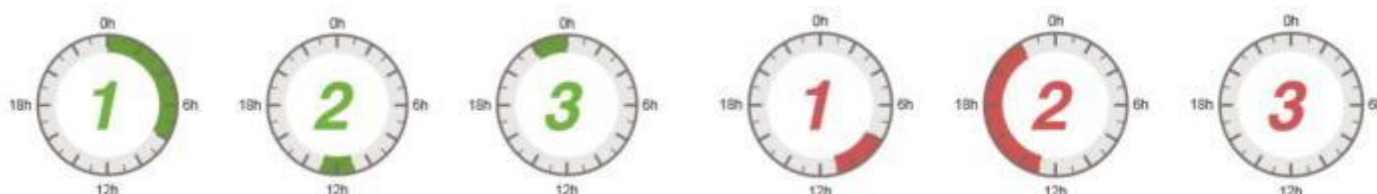

Three user-defined time slots are available, allowing users to freely set grid charging/loading periods from 00:00 to 23:59. During the user-set periods, solar energy will be prioritized if available. In the absence or insufficiency of solar energy output within the set periods, grid power will be used as a backup.

With 3 definable time periods, users can freely set the battery discharge time within the range of 00:00 to 23:59. During the time set by the user, the inverter will give priority to the battery inverter to carry the load, and if the battery power is insufficient, the inverter will automatically switch to mains power to ensure stable operation of the load.



## 5.4、 Battery parameter

- Lead-acid battery

| Battery type<br>Parameters      | Sealed lead acid battery | Gel lead acid battery | Flooded lead acid battery | User-defined              |
|---------------------------------|--------------------------|-----------------------|---------------------------|---------------------------|
|                                 | SLd                      | GEL                   | FLd                       | USE                       |
| Overdisconnect Voltage          | 60V                      | 60V                   | 60V                       | 60V                       |
| Boost charging voltage          | 57.6V                    | 56.8V                 | 57.6V                     | 40~60V<br>(can be set)    |
| Undervoltage alarm voltage      | 44V                      | 44V                   | 44V                       | 40~60V<br>(can be set)    |
| Undervoltage disconnect voltage | 42V                      | 42V                   | 42V                       | 40~60V<br>(can be set)    |
| Discharge limiting voltage      | 40V                      | 40V                   | 40V                       | 40~60V<br>(can be set)    |
| Overdischarge delay time        | 5s                       | 5s                    | 5s                        | 1~30s<br>(can be set)     |
| Enhanced Charge Cycle           | 120min                   | 120min                | 120min                    | 10~600min<br>(can be set) |

- Li-ion batter

| Battery type<br>Parameters      | Ternary                |                        | LFP                    |                        |                        | User-defined              |
|---------------------------------|------------------------|------------------------|------------------------|------------------------|------------------------|---------------------------|
|                                 | N13                    | N14                    | L16                    | L15                    | L14                    | USE                       |
| Overdisconnect Voltage          | 60V                    | 60V                    | 60V                    | 60V                    | 60V                    | 60V                       |
| Boost charging voltage          | 53.2V                  | 57.6V                  | 56.8V                  | 53.2V                  | 49.2V                  | 40~60V<br>(can be set)    |
| Undervoltage alarm voltage      | 43.6V                  | 46.8V                  | 49.6V                  | 46.4V                  | 43.2V                  | 40~60V<br>(can be set)    |
| Undervoltage disconnect voltage | 38.8V                  | 42V                    | 48.8V                  | 45.6V                  | 42V                    | 40~60V<br>(can be set)    |
| Discharge limiting voltage      | 36.4V                  | 39.2V                  | 46.4V                  | 43.6V                  | 40.8V                  | 40~60V<br>(can be set)    |
| Overdischarge delay time        | 30s                    | 30s                    | 30s                    | 30s                    | 30s                    | 1~30s<br>(can be set)     |
| Enhanced Charge Cycle           | 120min<br>(can be set) | 120min<br>(can be set) | 120min<br>(can be set) | 120min<br>(can be set) | 120min<br>(can be set) | 10~600min<br>(can be set) |

## 6. Communication

### 6.1. Overview

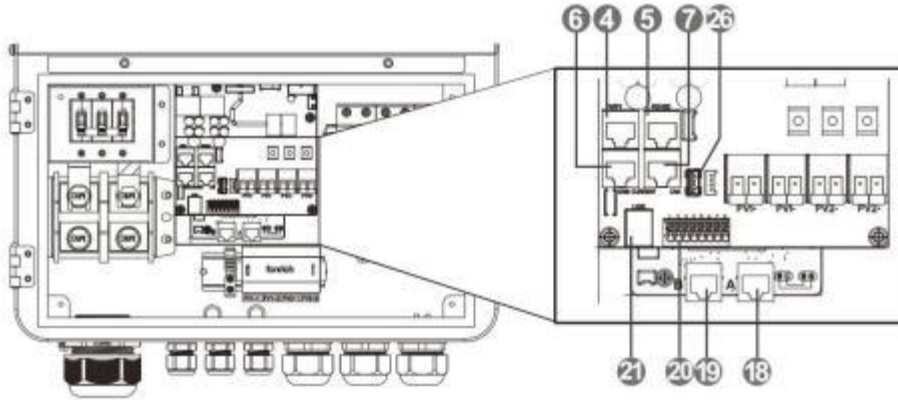

|    |                  |    |                 |
|----|------------------|----|-----------------|
| 4  | WIFI port        | 19 | Parallel port B |
| 5  | RS485 port       | 20 | Dry contact     |
| 6  | External CT port | 21 | USB-B port      |
| 7  | CAN port         | 26 | USB-A port      |
| 18 | Parallel port A  |    |                 |

### 6.2. USB-B port

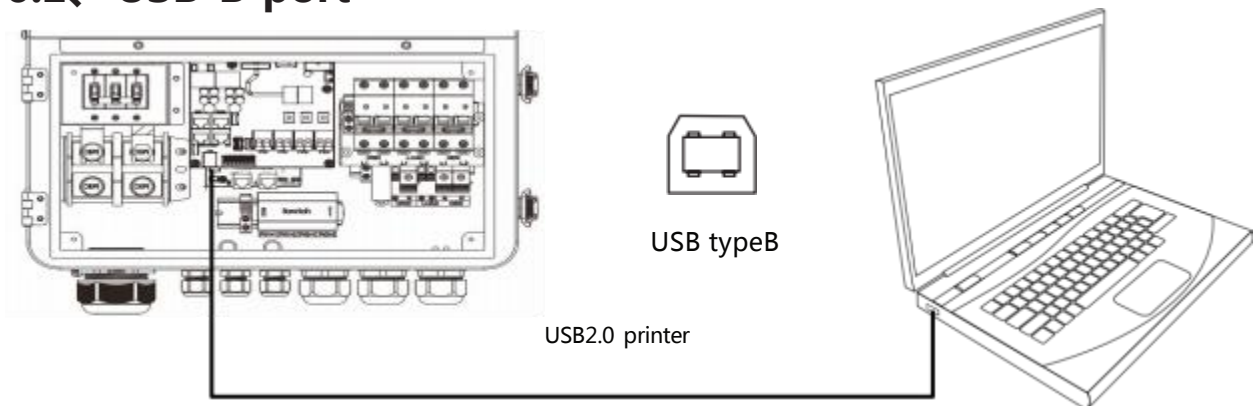

The user can read and modify device parameters through this port by using the host software. Please contact us for the host software installation package if you require one.

### 6.3、WIFI port

The WIFI port is used to connect to the Wi-Fi/GPRS data acquisition module, which allows users to view the operating status and parameters of the inverter through the cell phone APP.

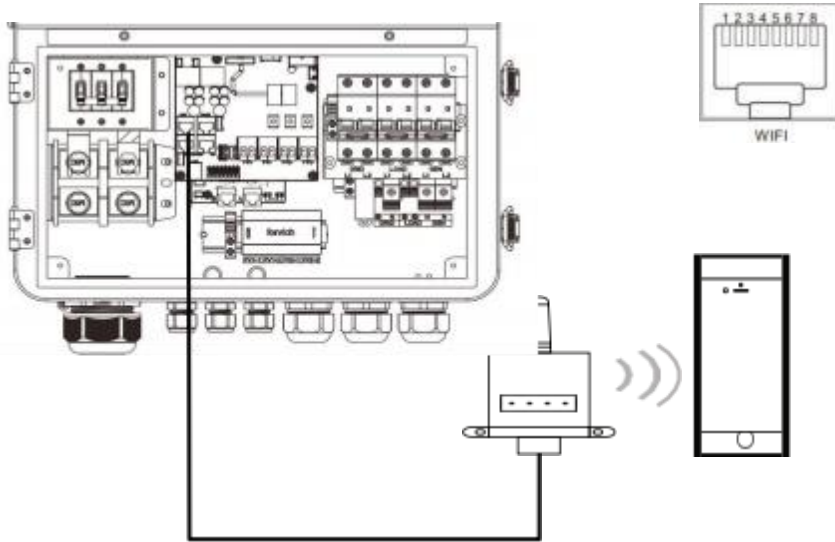

| RJ45  | Definition |
|-------|------------|
| Pin 1 | 5V         |
| Pin 2 | GND        |
| Pin 3 | /          |
| Pin 4 | /          |
| Pin 5 | /          |
| Pin 6 | /          |
| Pin 7 | RS485-A    |
| Pin 8 | RS485-B    |

### 6.4、RS485 port

The RS485 port is used to connect to the BMS of Liion battery.

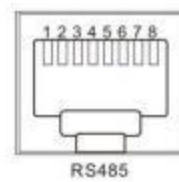

| RJ45  | 定义      |
|-------|---------|
| Pin 1 | /       |
| Pin 2 | /       |
| Pin 3 | /       |
| Pin 4 | CANH    |
| Pin 5 | CANL    |
| Pin 6 | /       |
| Pin 7 | RS485-A |
| Pin 8 | RS485-B |

## 6.5、CAN port

The CAN port is used to connect to the BMS of Liion battery .

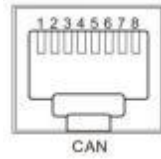

| RJ45  | Definition |
|-------|------------|
| Pin 1 | /          |
| Pin 2 | /          |
| Pin 3 | /          |
| Pin 4 | CANH       |
| Pin 5 | CANL       |
| Pin 6 | /          |
| Pin 7 | /          |
| Pin 8 | /          |



### NOTICE

If you need the inverter to communicate with the lithium battery BMS, please contact us for the communication protocol or to upgrade the inverter to the corresponding software program.

## 6.5、 External CT port

1. Length of CT Output Line Wrap : 4m
2. The CT direction is "to inverter"

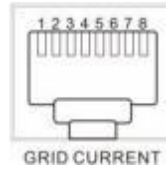

| RJ45  | Definition |
|-------|------------|
| Pin 1 | CT3+       |
| Pin 2 | CT3-       |
| Pin 3 | /          |
| Pin 4 | CT2+       |
| Pin 5 | CT2-       |
| Pin 6 | /          |
| Pin 7 | CT1+       |
| Pin 8 | CT1-       |

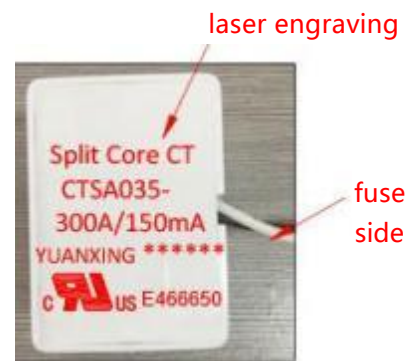
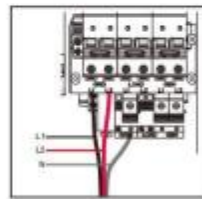
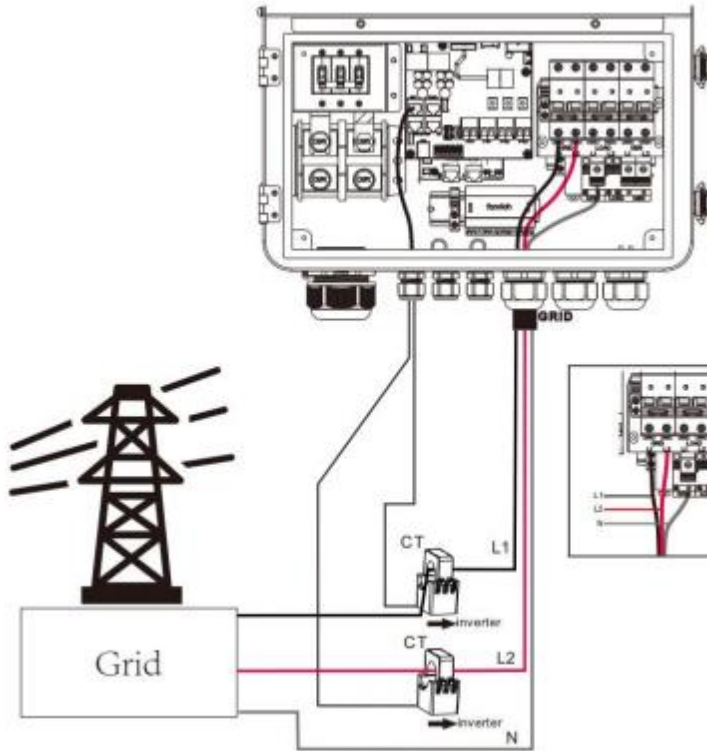

3. Current transformer (CT) dimensions:(mm)

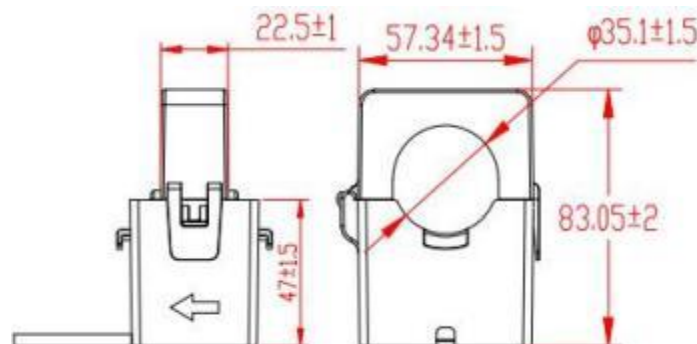

## 6.6、 Dry contact

Dry contact port with 4 functions:

1. RSD power supply
2. Temperature sampling (reserved)
3. Generator remote start/stop

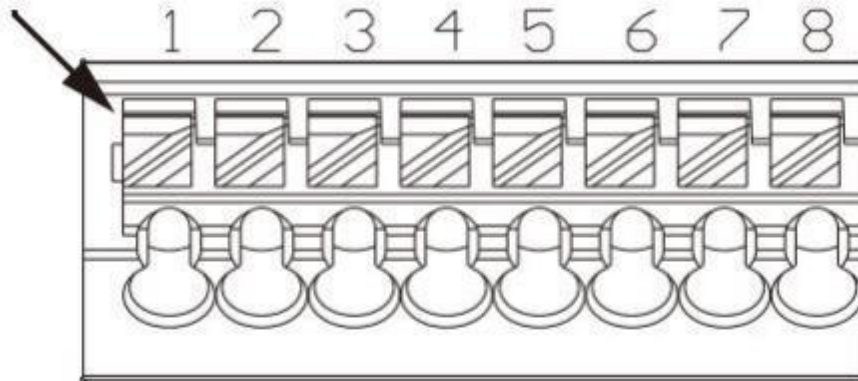

| Function                             | Description  |
|--------------------------------------|--|
| RSD power supply                     | PIN 1 is GND , PIN 2 is RSD 12V+   |
| Temperature sampling<br>( reserved ) | Pin 1 & Pin 5 can be used for battery temperature sampling compensation.   |
| Generator remote start/stop          | <p>When the generator is connected, the following conditions need to be met.</p> <ol style="list-style-type: none"> <li>1、 Remote start the generator when there is no grid connection.</li> <li>2、 When there is no BMS connection, the generator will be remotely started when the battery voltage is below the undervoltage alarm threshold or when the battery switches to the grid voltage.</li> <li>3、 When connected to the BMS, the generator will be remotely started when the battery SOC is lower than the set point for switching to grid SOC.</li> <li>4、 When there is no BMS connection, the generator will be remotely stopped when the battery voltage reaches the voltage threshold for switching from grid to battery, or when the battery is fully charged.</li> <li>5、 When the BMS is connected, the generator will be remotely shut down when the battery SOC is lower than the set value for switching from grid to battery SOC.</li> <li>6. Remote shutdown of the generator when the battery is fully charged.</li> </ol> <p><b>Remote start of the generator:</b><br/>Pin 6 to Pin 7 is normally open, Pin 7 to Pin 8 is normally closed.</p> <p><b>Remote generator shutdown:</b><br/>Pin 6 to 7 is normally closed, Pin 7 to 8 is normally open.<br/>(Pin 6/7/8 outputs 125Vac/1A, 230Vac/1A, 30Vdc/1A)</p> |

**NOTICE**

If you need to use the remote start/stop function of the generator with dry contact, ensure that the generator has ATS and supports remote start/stop.

## 7. Fault and Remedy

### 7.1 Fault code

| Fault code | Fault name        | Whether it affects the output or not | Description   |
|------------|-------------------|--------------------------------------|---|
| 01         | BatVoltLow        | Yes                                  | Battery undervoltage alarm.   |
| 02         | BatOverCurrSw     | Yes                                  | Battery discharge average current overcurrent (software protection).              |
| 03         | BatOpen           | Yes                                  | Battery not-connected alarm   |
| 04         | BatLowEod         | Yes                                  | Battery undervoltage stop discharge alarm.  |
| 05         | BatOverCurrHw     | Yes                                  | Battery overcurrent (hardware protection)   |
| 06         | BatOverVolt       | Yes                                  | Charging overvoltage protection   |
| 07         | BusOverVoltHw     | Yes                                  | Bus overvoltage (hardware protection)   |
| 08         | BusOverVoltSw     | Yes                                  | Bus overvoltage (software protection)   |
| 09         | PvVoltHigh        | Yes                                  | PV overvoltage protection.  |
| 10         | PvBoostOCSw       | No                                   | Boost overcurrent (software protection)   |
| 11         | PvBoostOCHw       | No                                   | Boost overcurrent (hardware protection)   |
| 12         | HESCommErr        | Yes                                  | Master-slave HES communication failure  |
| 13         | Overload Bypass   | Yes                                  | Bypass overload protection  |
| 14         | Overload Inverter | Yes                                  | Inverter overload protection.   |
| 15         | AcOverCurrHw      | Yes                                  | Inverter overcurrent hardware protection  |
| 16         | AuxDspReqOffPWM   | Yes                                  | Requesting a shutdown fault from the chip   |
| 17         | InvShort          | Yes                                  | Inverter short-circuit protection.  |
| 18         | Bussoftfailed     | Yes                                  | Bus soft start failure  |
| 19         | OverTemperMppt    | No                                   | Buck heat sink over temperature protection  |
| 20         | OverTemperInv     | Yes                                  | Inverter AC output with load or AC charging radiator over-temperature protection. |
| 21         | FanFail           | Yes                                  | Fan blockage or failure fault   |
| 22         | EEPROM            | Yes                                  | Memory failure  |
| 23         | Model NumErr      | Yes                                  | Model setting error   |
| 24         | Busdiff           | Yes <sup>48</sup>                    | Positive and negative bus voltage imbalance                                       |



|    |                                   |     |  |
|----|-----------------------------------|-----|--|
| 25 | BusShort                          | Yes | Busbar short circuit   |
| 26 | Rlyshort                          | Yes | Inverter AC output backfeed to bypass AC output  |
| 28 | LinePhaseErr                      | Yes | Utility input phase error  |
| 29 | BusVoltLow                        | Yes | Low bus voltage protection   |
| 30 | BatCapacityLow1                   | Yes | Alarm given when battery capacity rate is lower than 10% (setting BMS to enable validity). |
| 31 | BatCapacityLow2                   | No  | Alarm given when battery capacity rate is lower than 5% (setting BMS to enable validity).  |
| 32 | BatCapacityLowStop                | Yes | Inverter stops when battery capacity is low (setting BMS to enable validity).              |
| 34 | CanCommFault                      | Yes | CAN communication fault in parallel operation.   |
| 35 | ParaAddrErr                       | Yes | Parallel ID ( communication address ) setting error.                                       |
| 37 | ParaShareCurrErr                  | Yes | Parallel current sharing fault   |
| 38 | ParaBattVoltDiff                  | Yes | Large battery voltage difference in parallel mode.   |
| 39 | ParaAcSrcDiff                     | Yes | Inconsistent AC input source in parallel mode.   |
| 40 | ParaHwSynErr                      | Yes | Hardware synchronization signal error in parallel mode.                                    |
| 41 | InvDcVoltErr                      | Yes | Inverter DC voltage error.   |
| 42 | SysFwVersionDiff                  | Yes | Inconsistent system firmware version in parallel mode.                                     |
| 43 | ParaLineContErr                   | Yes | Parallel line connection error in parallel mode.   |
| 44 | Serial number error               | Yes | No serial number set at factory  |
| 45 | Error setting of split-phase mode | Yes | Item "Parallel" setting error  |
| 49 | Grid over voltage                 | Yes | Selects the local corresponding grid standard.   |
| 50 | Grid under voltage                | Yes |  |
| 51 | Grid over Frequency               | Yes |  |
| 52 | Grid under Frequency              | Yes |  |
| 53 | Grid loss                         | Yes |  |
| 54 | Grid DC current over              | Yes |  |
| 55 | Grid standard un init             | Yes |  |

|    |                                 |     |   |
|----|---------------------------------|-----|---|
| 56 | Low insulation resistance fault | No  | PV1+, PV2+ and PV- abnormally low impedance to ground.                                  |
| 57 | Leakage current overload fault  | Yes | System leakage current exceeds limit.   |
| 58 | BMSComErr                       | No  | BMS communication failure   |
| 60 | BMSUnderTem                     | No  | BMS alarm battery low temperature.  |
| 61 | BMSOverTem                      | Yes | BMS alarm battery over temperature.<br>( Effective after successful BMS communication ) |
| 62 | BMSOverCur                      | Yes | BMS alarm battery over current.<br>( Effective after successful BMS communication )     |
| 63 | BMSUnderVolt                    | No  | BMS alarm low battery.<br>( Effective after successful BMS communication )              |

## 7.2、Troubleshooting

| Fault code       | Faults   | Remedy  |
|------------------|--|---|
| <b>Display</b>   | No display on the screen                                 | Check if the battery switch or PV switch is closed; whether the switch is in the "ON" state; press any button on the screen to exit the screen sleep mode                     |
| <b>[06]</b>      | Battery overvoltage protection                           | Check that the battery voltage does not exceed the protection value. If it does, discharge the battery until the voltage falls below the battery over-voltage recovery point. |
| <b>[01] [04]</b> | Battery undervoltage protection                          | Charge the battery until it returns to the low voltage disconnection recovery voltage.  |
| <b>[21]</b>      | Fan failure  | Check if the fan is not turning or blocked by foreign object.   |
| <b>[19] [20]</b> | Heat sink over temperature protection                    | When the temperature of the device is cooled below the recovery temperature, normal charge and discharge control is resumed.  |
| <b>[13] [14]</b> | Bypass overload protection, inverter overload protection | ① Reduce the use of power equipment;<br>② Restart the unit to resume load output.   |
| <b>[17]</b>      | Inverter short-circuit protection                        | ① Check the load connection carefully and clear the short-circuit fault points;<br>② Re-power up to resume load output.   |
| <b>[09]</b>      | PV overvoltage   | Use a multimeter to check if the PV input voltage exceeds the maximum allowable input voltage rated.  |
| <b>[03]</b>      | Battery disconnected alarm                               | Check if the battery is not connected or if the battery circuit breaker is not closed.  |
| <b>[40] [43]</b> | Parallel connection fault                                | Check if the parallel line is not connected well, such as loose or wrong connection.  |
| <b>[35]</b>      | Parallel ID setting error                                | Check whether the setting of parallel ID number is repeated.  |
| <b>[37]</b>      | Parallel current sharing fault                           | Check if the parallel current sharing line is not connected well, such as loose or wrong connection.  |
| <b>[39]</b>      | Inconsistent AC input source in parallel mode            | Check whether the parallel AC inputs are from the same input interface  |
| <b>[42]</b>      | Inconsistent system firmware version in parallel mode    | Check whether the software version of each inverter is consistent.  |
| <b>[44]</b>      | Serial number error                                      | Incorrect device serial number setting.   |

|             |   |   |
|-------------|---|---|
| <b>[45]</b> | Parallel mode error                           | There is a device in the parallel system with the wrong parallel mode setting.  |
| <b>[49]</b> | High grid voltage                             | Check that the grid voltage is within the normal range, if the grid voltage is abnormal, wait until the grid voltage is restored.       |
| <b>[50]</b> | Low grid voltage                              | Check that the grid voltage is within the normal range, if the grid voltage is abnormal, wait until the grid voltage is restored.       |
| <b>[51]</b> | High grid frequency                           | Check that the grid frequency is within the normal range, if the grid frequency is abnormal, wait until the grid frequency is restored. |
| <b>[52]</b> | Low grid frequency                            | Check that the grid frequency is within the normal range, if the grid frequency is abnormal, wait until the grid frequency is restored. |
| <b>[53]</b> | Grid unconnected                              | Check if the grid is correctly connected, e.g. if the switch is closed and if the grid is disconnected.                                 |
| <b>[54]</b> | Grid-connected current with DC component over | Power down and restart the device, if it continues to report faults, contact the manufacturer after sales.                              |
| <b>[55]</b> | Grid standard not set                         | Setting standards for grid integration  |
| <b>[56]</b> | Low insulation resistance fault               | Check that the system is well grounded and that the PV modules and cables are not worn  |
| <b>[57]</b> | Leakage current overload fault                | Check that the system is well grounded and that the loads are not operating abnormally.   |

**① NOTICE**

If you encounter a fault with the product that cannot be solved by the methods in the table above, please contact our after-sales service for technical support and do not disassemble the equipment yourself.

## 8. Protection and Maintenance

### 8.1 Protection features

| No | Protection Feature             | Instruction  |
|----|--------------------------------|--|
| 1  | PV current limiting protection | When the charging current or power of the PV array configured exceeds the PV input rated value, the inverter will limit the input power and charge at the rated. |

|    |                                       |   |
|----|---------------------------------------|---|
| 2  | PV input over-voltage                 | If the PV voltage exceeds the maximum value allowed by the hardware, the machine will report a fault and stop the PV boost to output a sinusoidal AC wave.  |
| 3  | PV night reverse current protection   | At night, the battery is prevented from discharging through the PV module because the battery voltage is greater than the voltage of PV module.   |
| 4  | Utility input overvoltage protection  | When the mains voltage exceeds 140Vac, the mains charging will be stopped and the output will be inverted.  |
| 5  | AC input under-voltage protection     | When the mains voltage falls below 90Vac, the mains charging will be stopped and the output will be inverted.   |
| 6  | Battery over-voltage protection       | When the battery voltage reaches the over-voltage cut-off point, the PV and the utility will automatically stop charging to prevent the battery from being overcharged and damaged.   |
| 7  | Battery under-voltage protection      | When the battery voltage reaches the under-voltage cut-off point, the inverter will automatically stop the battery discharge to prevent damage from over-discharging the battery  |
| 8  | Battery over-current protection       | After a period when the battery current exceeds that allowed by the hardware, the machine will switch off the output and stop discharging the battery.  |
| 9  | AC output short-circuit protection    | When a short-circuit fault occurs at the load output for more than 200ms, the output AC voltage will be turned off immediately, and then manually re-powered and turned on before normal output can be restored. (Non-utility bypass condition)   |
| 10 | Heat sink over-temperature protection | When the internal temperature of the inverter is too high, the inverter will stop charging and discharging; when the temperature returns to normal, the inverter will resume charging and discharging.  |
| 11 | Inverter over-load protection         | After triggering the overload protection the inverter will resume output after 3 minutes, 5 consecutive overloads will switch off the output until the inverter is restarted.<br>(102% < load < 110%) : alarm and output shutdown after 5min; (110% < load < 125%) : alarm and output shutdown after 10s.<br>( Load > 125% : alarm reported and output switched off after 5s. |
| 12 | AC output reverse                     | Prevents AC back flow from the battery inverter to the bypass AC input.   |
| 13 | Bypass over-current protection        | Built-in AC input over-current protection circuit breaker   |
| 14 | Bypass phase inconsistency protection | When the phase of the bypass input and the phase of the inverter split do not match, the inverter disables switching to the bypass output to prevent the load from dropping out or short-circuiting when switching to the bypass.   |

## 8.2 Maintenance

**To maintain optimum and long-lasting working performance, we recommend that the following items are checked twice a year.**

- 1.Ensure that the airflow around the inverter is not blocked and remove any dirt or debris from the radiator.
2. Check that all exposed conductors are not damaged by sunlight, friction with other surrounding objects, dry rot, insect or rodent damage, etc. The conductors need to be repaired or replaced if necessary.
3. Verify that the indications and displays are consistent with the operation of the equipment, note any faults or incorrect displays and take corrective action if necessary.
4. Check all terminals for signs of corrosion, insulation damage, high temperatures or

burning/discolouration

and tighten terminal screws.

5. Check for dirt, nesting insects and corrosion, clean as required , Clean the insect screen regularly.
6. If the lightning arrester has failed, replace the failed arrester in time to prevent lightning damage to the inverter or other equipment of the user.

 **DANGER**

Make sure that the inverter is disconnected from all power sources and that the capacitors are fully discharged before carrying out any checks or operations to avoid the risk of electric shock.

**The Company shall not be liable for damage caused by :**

- 1.Damage caused by improper use or use in a wrong location.
- 2.Photovoltaic modules with an open circuit voltage exceeding the maximum permissible voltage.
- 3.Damage caused by the operating temperature exceeding the restricted operating temperature range
4. Dismantling and repair of the inverter by unauthorised persons.
5. Damage caused by force majeure: damage during transport or handling of the inverter.

## 9. Datasheet

| MODEL                           | SEI-8K-UP   | SEI-10K-UP                 | SEI-12K-UP                   | Settable |
|---------------------------------|---|----------------------------|------------------------------|----------|
| <b>Inverter output</b>          |   |                            |                              |          |
| Rated Output Power              | 8800W   | 10,000W                    | @240V 12000W<br>@208V 10400W |          |
| Max. Peak Power                 | 2 times rated power   |                            |                              |          |
| Rated Output Voltage            | 120/240Vac ( Split-phase ) 120/208V(Three-phase)  |                            |                              | √        |
| Output voltage error            | @240V 36.6A<br>@208V 42.3A  | @240V 41.7A<br>@208V 48.1A | 50A                          |          |
| Load Capacity of Motors         | 5HP   | 6HP                        | 6HP                          |          |
| Rated AC Frequency              | 50/60Hz   |                            |                              | √        |
| Waveform                        | Pure Sine Wave  |                            |                              |          |
| Parallel capacity               | 6   |                            |                              |          |
| Overload                        | <p>After triggering the overload protection the inverter will resume output after 3 minutes, 5 consecutive overloads will switch off the output until the inverter is restarted.</p> <p>(102% &lt; load &lt; 110%): alarm and output shutdown after 5min.<br/>           (110% &lt; load &lt; 125%) : alarm and output shutdown after 10s.<br/>           (Load &gt; 125%) : alarm reported and output switched off after 5s.</p> |                            |                              |          |
| <b>Battery</b>                  |   |                            |                              |          |
| Battery Type                    | Li-ion / Lead-Acid / User Defined   |                            |                              | √        |
| Rated Battery Voltage           | 48Vdc   |                            |                              |          |
| Voltage Range                   | 40-60Vdc  |                            |                              | √        |
| Max. PV Charging Current        | 200A  |                            |                              | √        |
| Max. Grid Charging Current      | 120A  |                            |                              | √        |
| Max. Generator Charging Current | 60A   |                            |                              | √        |
| Max. Hybrid Charging Current    | 200A  |                            |                              | √        |
| <b>PV input</b>                 |   |                            |                              |          |
| Num. of MPP Trackers            | 2   |                            |                              |          |
| Max. PV array power             | 5500W/5500W   | 5500W/5500W                | 6600W/6600W                  |          |
| Max. input current              | 25A+25A   |                            |                              |          |
| Max. Voltage of Open Circuit    | 550Vdc+550Vdc   |                            |                              |          |
| MPPT Voltage Range              | 125-450Vdc/125-450Vdc   |                            |                              |          |
| <b>Grid / Generator input</b>   |   |                            |                              |          |
| Input Voltage Range             | 90-140Vac   |                            |                              |          |
| Frequency Range                 | 50/60Hz   |                            |                              |          |

| <b>Efficiency</b>                |   |   |
|----------------------------------|---|---|
| MPPT Tracking Efficiency         | 99.9%                                     |   |
| Max Efficiency                   | 97.5%                                     |   |
| CEC Efficiency                   | 96.5%                                     |   |
| <b>Basic data</b>                |   |   |
| Dimensions                       | 750*440*240mm                             |   |
| Weight                           | 42kg                                      |   |
| Protection Degree                | IP65                                      |   |
| Operating Temperature Range      | -25 ~60°C, >45°C derated                  |   |
| Noise                            | <60dB                                     |   |
| Cooling Method                   | Heat sink + intelligent fan cooling       |   |
| <b>Communication</b>             |   |   |
| Communication port               | RS485 / CAN / USB / Dry contact           | √ |
| External Modules<br>( Optional ) | Wi-Fi / GPRS                              | √ |
| <b>Certified specifications</b>  |   |   |
| Safety standards                 | UL1741&IEEE1547.1-2020,CEC, RULE 21, HECO |   |
| EMC                              | FCC 15 class B                            |   |
| RoHS                             | Yes                                       |   |